

COMPLETE CLASSROOM SOLUTIONS  
PRESENTATION & COLLABORATION  
VIDEOPROJECTION & LARGE FORMAT DISPLAYS  
PROFESSIONAL MOUNTS · PRO AUDIO & PRO VIDEO  
VIDEOCONFERENCE WEBCAST & STREAMING  
LECTURE CAPTURE · DIGITAL SIGNAGE · MULTIMEDIA KIOSKS  
INTERACTIVE TECHNOLOGIES  
SIGNAL MANAGEMENT, DISTRIBUTION AND ROUTING  
CONTROL & AUTOMATION  
SPECIALIZED TECHNICAL INSTALLATIONS  
AV PROJECTS CONSULTING

**é**<sup>®</sup> **SISTEMAS**  
VISUAL COMMUNICATION SOLUTIONS  
MULTIMEDIA PRODUCTS



**new year  
new solutions**

*Catalog*

**education solutions**

**19.20**

*We Create Audiovisual and Multimedia Solutions*

“Work with  
people who  
love what  
they do.”

# Soluções para Educação



**Education** Solutions

**19.20**

*Catalog*

*índice*

# Education Solutions

<b>.01</b> VÍDEOPROJEÇÃO ..... 04	<b>.08</b> GESTÃO DE SINAL DIGITAL ..... 34
<b>.02</b> ECRANS DE PROJEÇÃO ..... 10	<b>.09</b> VÍDEO PROFISSIONAL ..... 36
<b>.03</b> SOLUÇÕES INTERATIVAS ..... 12	<b>.10</b> ÁUDIO E COMPLEMENTOS AV ..... 38
<b>.04</b> DISPLAYS PROFISSIONAIS ..... 17	<b>.11</b> SISTEMAS DE CONFERÊNCIA ..... 42
<b>.05</b> QUIOSQUES / DIGITAL SIGNAGE ..... 18	<b>.12</b> SOLUÇÕES EM SUPORTES ..... 44
<b>.06</b> SOLUÇÕES COLABORATIVAS ..... 20	<b>.13</b> MOBILIÁRIO / MATERIAL DIDÁTICO ..... 50
<b>.07</b> CONTROLO E INTEGRAÇÃO ..... 32	<b>.14</b> CONTRATOS MANUTENÇÃO ..... 52

**19.20**  
*Catalog*

# 01. VÍDEOPROJEÇÃO



SVGA, XGA, WXGA, 1080P, WUXGA



**Info** VÁRIOS MODELOS E OPÇÕES DISPONÍVEIS  
CONSULTE-NOS PARA MAIS INFORMAÇÕES

**+**  
**GAMA ULTRA MOBILE / LED**  
RESOLUÇÕES ATÉ FULL HD  
ATÉ 3100 ANSI LUMENS  
HDMI, MHL, USB



**+**  
**GAMA MOBILE**  
RESOLUÇÕES ATÉ FULL HD  
ATÉ 4000 ANSI LUMENS  
FULL 3D, AMPLA CONECTIVIDADE



**+**  
**GAMA DESKTOP · INSTALL**  
RESOLUÇÕES ATÉ FULL HD  
ATÉ 6000 ANSI LUMENS  
AMPLA CONECTIVIDADE



**WIRELESS ACESSÓRIOS**

**+**  
QuickCast  
HDCast Pro  
Wireless USB Adapter  
Wireless HDMI System  
WHD200



# SHORT THROW series ULTRA SHORT THROW series



**GAMA CURTA DISTÂNCIA**  
RESOLUÇÕES ATÉ FULL HD  
ATÉ 3600 ANSI LUMENS  
AMPLA CONECTIVIDADE



**GAMA ULTRA CURTA DISTÂNCIA**  
RESOLUÇÕES ATÉ FULL HD  
ATÉ 4000 ANSI LUMENS  
AMPLA CONECTIVIDADE

XGA, WXGA, 1080P, WUXGA

**Info** VÁRIOS MODELOS E OPÇÕES DISPONÍVEIS  
CONSULTE-NOS PARA MAIS INFORMAÇÕES



—  
**PICTURE BY DLP**  
 TEXAS INSTRUMENTS  
**LCD**  
 —  
**3D**  
 PROJECTION  
 —  
**CONFIRMAR OS MODELOS**



**GAMA MOBILE**  
RESOLUÇÕES ATÉ FULL HD  
ATÉ 3300 ANSI LUMENS  
HDMI



**GAMA DESKTOP**  
RESOLUÇÕES ATÉ FULL HD  
ATÉ 4000 ANSI LUMENS  
DICOM (VER MODELOS)



**GAMA PRO**  
RESOLUÇÕES ATÉ FULL HD  
ATÉ 6000 ANSI LUMENS  
AMPLA CONECTIVIDADE



**3**  
ANOS  
GARANTIA

(ON SITE)  
VÁLIDO PARA  
TODOS OS MODELOS

WIRELESS  
PRESENTATION

MultiPresenter



**ATÉ 20.000<sup>h</sup>**  
VIDA ÚTIL  
ATÉ 20.000 Horas  
(Ver Modelos)



**SOLUÇÃO DE APRESENTAÇÃO WIRELESS PARA VÍDEOPROJETORES E DISPLAYS NEC®**

**+**  
**GAMA ULTRA CURTA DISTÂNCIA**  
 RESOLUÇÕES ATÉ FULL HD  
 ATÉ 3600 ANSI LUMENS  
 AMPLA CONECTIVIDADE



**+**  
**GAMA CURTA DISTÂNCIA**  
 RESOLUÇÕES ATÉ WXGA  
 ATÉ 3500 ANSI LUMENS  
 AMPLA CONECTIVIDADE

**SHORT THROW** series  
**ULTRA SHORT THROW** series



PRÓXIMA GERAÇÃO  
 APRENDIZAGEM INTERATIVA  
**DISPLAYNOTE**



# 01. VÍDEOPROJEÇÃO

**CASIO**  
PROJECTORS

XGA, WXGA, WUXGA, 4K

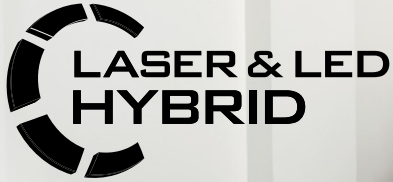

## THE NO LAMP PROJECTORS

OS VÍDEOPROJETORES SEM LÂMPADA

 **LampFree**  
CASIO Green Technology

LOW MAINTENANCE | MERCURY FREE

EM TODOS OS MODELOS  
GARANTIA ATÉ 5 ANOS



**+**  
**GAMA LARGE VENUE**  
RESOLUÇÃO 4K UHD  
5000 ANSI LUMENS  
AMPLA CONECTIVIDADE

**+**  
**GAMA UST**  
RESOLUÇÕES ATÉ WXGA  
ATÉ 3500 ANSI LUMENS  
AMPLA CONECTIVIDADE

**+**  
**GAMA GREEN SLIM**  
RESOLUÇÕES ATÉ WXGA  
ATÉ 3000 ANSI LUMENS  
AMPLA CONECTIVIDADE

**+**  
**GAMA CORE**  
RESOLUÇÕES ATÉ WXGA  
ATÉ 3500 ANSI LUMENS  
AMPLA CONECTIVIDADE

**+**  
**GAMA ADVANCED**  
RESOLUÇÕES ATÉ WXGA  
ATÉ 3500 ANSI LUMENS  
AMPLA CONECTIVIDADE

**GAMA SUPERIOR**  
RESOLUÇÕES ATÉ WUXGA  
ATÉ 4000 ANSI LUMENS  
AMPLA CONECTIVIDADE

# O SEU SITE DE LÂMPADAS

fastlamps.pt



APOIO AO **CLIENTE** 

+351 22 955 84 56 | +351 21 240 50 70

fastlamps.pt | sales@fastlamps.pt

## 02. ECRANS DE PROJEÇÃO

**Info**

VÁRIOS MODELOS E  
OPÇÕES DISPONÍVEIS  
CONSULTE-NOS PARA  
MAIS INFORMAÇÕES

**ecrans de  
projeção**

as melhores soluções  
para a sua sala de  
aula, auditório ou  
sala de formação

IMAGEM - PROJEÇÃO

**Soluções  
para  
Educação**

elétricos

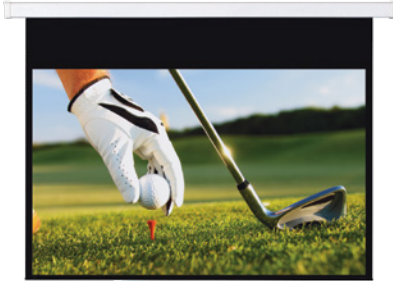

**+**  
**SUSPENSÃO ELÉTRICOS**  
 MOLDURAS NEGRAS · DROP SUPERIOR  
 FORMATO 4:3 · 16:9 · 16:10  
 COMANDO IR/RF  
 INSTALAÇÃO PAREDE / TETO

**Disponível**  
 150CM A 1200CM

tensionados



**+**  
**SUSPENSÃO TENSIONADOS**  
 MOLDURAS NEGRAS · DROP SUPERIOR  
 FORMATO 4:3 · 16:9 · 16:10  
 COMANDO IR/RF  
 INSTALAÇÃO PAREDE / TETO

**Disponível**  
 200CM A 700CM

encastrar



**+**  
**SUSPENSÃO ENCASTRAR**  
 MOLDURAS NEGRAS · DROP SUPERIOR  
 FORMATO 4:3 · 16:9 · 16:10  
 COMANDO IR/RF  
 INSTALAÇÃO ENCASTRAR

**Disponível**  
 200CM A 700CM

manuals



**+**  
**SUSPENSÃO MANUAIS**  
 MOLDURAS NEGRAS · DROP SUPERIOR  
 FORMATO 4:3 · 16:9  
 SUBIDA LENTA  
 INSTALAÇÃO PAREDE / TETO

**Disponível**  
 150CM A 300CM

tripé



**+**  
**TRIPÉ**  
 MOLDURAS NEGRAS  
 CORREÇÃO KEYSTONE  
 FORMATO 1:1 · 4:3 · 16:9  
 INSTALAÇÃO CHÃO

**Disponível**  
 150CM A 200CM

portáteis



**+**  
**PORTÁTEIS**  
 MOLDURAS NEGRAS  
 DROP INFERIOR  
 FORMATO 4:3 · 16:9  
 INSTALAÇÃO CHÃO / MESA

**Disponível**  
 65CM A 170CM

VÁRIAS MARCAS E OPÇÕES DISPONÍVEIS





SMART  
kapp



## Software

SMART  
Remote Management

ANY DEVICE.  
ANY LOCATION.

Software de  
Gestão Remota  
para Displays  
SMART



SMART Learning Suite

online

45-day  
free trial

[suite.smarttech.com](http://suite.smarttech.com)



SMART Board®  
Document Camera™ 550

**SDC 550**

HDMI | 1080P VIDEO OUTPUT  
12x ZOOM DIGITAL  
WINDOWS / MAC OS X



\*Fechado



IMAGENS SMART®

INTERACTIVE  
**DISPLAYS**

---

**SMART Board®**

---

**7000 series**  
**6000 series**  
**MX series**

 **SMART Learning Suite**  
SOFTWARE INCLuíDO

**65" | 75" | 86"**  
TAMANHOS  
DISPONÍVEIS

**Info** VÁRIOS MODELOS E  
OPÇÕES DISPONÍVEIS  
CONSULTE-NOS PARA  
MAIS INFORMAÇÕES

# IMPROVING STUDENT LEARNING

É FÁCIL FAZER APRESENTAÇÕES  
SURPREENDENTES COM TURNINGPOINT



FAÇA UMA PERGUNTA



OS PARTICIPANTES  
RESPONDEM



REUNIR RESULTADOS



REALIZAR RELATÓRIOS  
DETALHADOS

# SOFTWARE SOLUTIONS FOR INTERACTIVE AUDIENCE

PLATAFORMA DE PARTICIPAÇÃO QUE NÃO SÓ FORNECE VOTAÇÃO AO VIVO E CAPACIDADES INTERATIVAS, MAS TAMBÉM LHE PERMITE REALIZAR PESQUISAS SOBRE OS SEUS CLIENTES, FUNCIONÁRIOS OU ALUNOS. INTERFACE SIMPLES, COM A CAPACIDADE DE RESPONDER USANDO UM TELEFONE, TABLET OU COMPUTADOR.



**Info** VÁRIOS MODELOS E OPÇÕES DISPONÍVEIS CONSULTE-NOS PARA MAIS INFORMAÇÕES

**+**  
TURNINGPOINT WEB  
TURNINGPOINT DESKTOP

**+**  
TURNINGPOINT APP



**SISTEMAS DE VOTAÇÃO E GESTÃO DE AUDIÊNCIAS**

**+**  
QT2  
LCD  
BRAILLE



SKY NOVA



SINTA O PODER DO TOQUE!  
RENDA-SE À TECNOLOGIA TÁTIL!

WITHOUT TOUCH, IT IS IMPOSSIBLE TO IMAGINE A CONNECTED WORLD!

SKY | NOVA

**DISPLAY INTERATIVO**  
RESOLUÇÃO ATÉ UHD  
ATÉ 32 PONTOS (TOQUES)  
7 ANOS DE GARANTIA  
PLAYER ANDROID E  
WI-FI HUB INTEGRADOS

55" | 65" | 75" | 86"

VÁRIOS TAMANHOS DISPONÍVEIS

7 ANOS GARANTIA

	<b>4K</b> ULTRA HD		 32 POINT TOUCH	 by HARMAN

MAKE EVERY EXPERIENCE GREAT  
PROVIDING EXTRA ARM LENGTH WITH UWAND  
MULTIPLE TOUCH INPUTS  
EASY DIRECT ACCESSIBLE CONNECTIONS  
80 WATTS TO POWER YOUR PRESENTATION  
SMART ENERGY SAVING

AMPLA GAMA DE ACESSÓRIOS  
CONSULTE-NOS



\*MAGNETIC TOUCH PEN  
VÁRIAS CORES DISPONÍVEIS

SUPORTE ELÉTRICO  
PAREDE OU CHÃO





**DESKTOP DISPLAYS**

17" | 19" | 20" | 21.5" | 22" | 23" | 23.5" | 24" | 27" | 29" | 30" | 32"



**DESKTOP DISPLAYS SERIES**  
AS | E | EA  
P | PA

**SPECTRA VIEW**

23" | 24.1" | 27" | 29.8" | 31.5"



**LARGE FORMAT DISPLAYS**

32" | 40" | 42" | 46" | 47" | 48" | 50" | 55" | 65" | 70" | 75" | 80" | 84" | 90" | 98"



**LARGE DISPLAYS SERIES**  
E|C|V|P|X

**E SERIES**

IDEAL PARA RETAIL SIGNAGE, CONFERÊNCIAS E INSTALAÇÕES CORPORATIVAS DE BAIXO CUSTO ATÉ 12/7

**C SERIES**

IDEAL PARA COMÉRCIO DIGITAL SIGNAGE, CONFERÊNCIAS E RECEÇÕES ATÉ 24/7

**V SERIES**

IDEAL PARA RETAIL SIGNAGE, CONFERÊNCIAS E INSTALAÇÕES EM HOTÉIS E RECEÇÕES ATÉ 24/7

**P SERIES**

DESENHADO PARA UMA AMPLA GAMA DE APLICAÇÕES COMO RETAIL SIGNAGE, SALAS DE CONTROLO E CONFERÊNCIA ATÉ 24/7

**X SERIES**

AMPLA GAMA DE APLICAÇÕES COMO RETAIL SIGNAGE, SALAS DE CONTROLO E CONFERÊNCIA, RECEÇÕES, TOTEMS E VIDEOWALL ATÉ 24/7



Exemplo Video Wall 3x3



IMAGEM NEC® LARGE FORMAT DISPLAYS

**3**

ANOS GARANTIA

(ON SITE) VÁLIDO PARA TODOS OS MODELOS

# 05. QUIOSQUES MULTIMÉDIA / DIGITAL SIGNAGE

## SIMPLES E FUNCIONAL A INOVAÇÃO MULTITOUCH

DEMONSTRAÇÕES  
DE PRODUTOS  
PONTOS DE  
INFORMAÇÃO



DIGITAL  
SIGNAGE  
QUIOSQUES  
DIGITAIS E MUPIS



VÁRIOS MODELOS E  
OPÇÕES DISPONÍVEIS  
CONSULTE-NOS PARA  
MAIS INFORMAÇÕES

# SOLUÇÕES DIGITAL SIGNAGE

## SISTEMAS DE MEDIÇÃO DE AUDIÊNCIA

### QUIOSQUES DIGITAIS CORPORATE TV

**OS SISTEMAS DE CORPORATE TV OU DIGITAL SIGNAGE** PERMITEM A CRIAÇÃO E GESTÃO DE CONTEÚDOS MULTIMÉDIA (IMAGENS, VÍDEOS, NOTÍCIAS, CONTEÚDOS WEB, ETC.) E A SUA DISPONIBILIZAÇÃO POR UM OU VÁRIOS DISPLAYS. ESTES PODEM ESTAR NO MESMO LOCAL ONDE ESTÁ INSTALADO O SOFTWARE OU ENTÃO ESTAR EM LOCAIS REMOTOS. A ATUALIZAÇÃO DOS CONTEÚDOS PODE SER EFETUADA DE FORMA REMOTA, PERMITINDO DESTA FORMA QUE AS ATUALIZAÇÕES DE CONTEÚDOS EM DEZENAS OU MESMO CENTENAS DE DISPLAYS POSSAM SER EFETUADAS DE FORMA EFICAZ E EM POUCOS SEGUNDOS.

Software  
**e-sign**

Composto por  
2 aplicações:  
**Desktop+Player**



**+**  
PODE SER UTILIZADO  
EM DIVERSOS LOCAIS  
E COM DIVERSAS  
FUNCIONALIDADES.

**CAMPANHAS OUTDOOR  
PONTOS DE INFORMAÇÃO  
E LOCAIS DE GRANDE  
AFLUÊNCIA DE PÚBLICO.**

**+**  
PRINCIPAIS ÁREAS  
**EDUCAÇÃO  
SAÚDE  
CORPORATE  
TURISMO  
COMÉRCIO E RETALHO  
MERCADO FINANCEIRO**



**APLICAÇÃO  
DESKTOP**

Permite configurar a apresentação dos conteúdos no display, através de uma aplicação que poderá estar instalada no seu desktop como poderá também funcionar através de plataforma Web. Crie layouts apelativos em HD de uma forma simples.

**APLICAÇÃO  
PLAYER**

Esta aplicação é responsável pela apresentação dos layouts criados. Apenas é necessário correr a aplicação que automaticamente os conteúdos serão apresentados.

## FILAS DE ESPERA

**Info**  
VÁRIOS MODELOS E  
OPÇÕES DISPONÍVEIS  
CONSULTE-NOS PARA  
MAIS INFORMAÇÕES

**SOFTWARE DE GESTÃO DE ATENDIMENTO E FILAS DE ESPERA**

ASSOCIADO A QUIOSQUES MULTIMÉDIA COM TOUCHSCREEN, QUIOSQUES DIGITAIS OU SIMPLES DISPENSADORES DE SENHAS DE PAPEL.

PERMITE OTIMIZAR O TEMPO DE ESPERA DOS CLIENTES E ACIMA DE TUDO EFETUAR A ORGANIZAÇÃO E GESTÃO DA CHAMADA DE CLIENTES/UTENTES DE UMA FORMA EFICAZ, RÁPIDA E SIMPLES PARA QUALQUER EMPRESA OU ENTIDADE.

**“DIRECIONA E ENTRETÉM O CLIENTE, ORGANIZA E DISTRIBUI MELHOR OS RECURSOS HUMANOS”**



## VIDEOCONFERÊNCIA HD PROFISSIONAL EM QUALQUER LUGAR! PROFESSIONAL HD VIDEOCONFERENCE FROM ANYWHERE!

### INTEROPERABILIDADE

O MAIS POTENTE AGREGADOR DE TECNOLOGIAS. LIGUE-SE NA MESMA CHAMADA COM SKYPE TRADICIONAL, SKYPE 4B, H.323 (CISCO, SONY, POLYCOM,ETC), TELEFONES SIP, WEBRTC BROWSER (CHROME, FIREFOX, IE, OPERA).

### SEM INVESTIMENTO EM INFRAESTRUTURA HW

SAAS – SOFTWARE AS A SERVICE SEM CONTRATO DE PERMANÊNCIA.

### SOLUÇÕES À MEDIDA

TEM NECESSIDADES ESPECÍFICAS? CRIAMOS UM PACOTE PERSONALIZADO PARA SI.

### FACILIDADE DE USO

ACEDA ATRAVÉS DE QUALQUER SISTEMA VC H.323 (CISCO, SONY, POLYCOM,ETC), PC/MAC/LINUX, SMARTPHONE OU TABLET IOS/ANDROID.

### INTEGRAÇÃO COM SERVIÇOS EXTERNOS DE STREAMING E GRAVAÇÃO

INTEGRE COM YOUTUBE, WOOZA, VBRICK, ETC...

### IMAGEM CORPORATIVA CUSTOMIZADA

POSSIBILIDADE DE CUSTOMIZAÇÃO DO LAYOUT COM A SUA IMAGEM. (NO SERVIÇO GOTOTAL)



#### REFERÊNCIAS

M.N.E. / MAOC / AGUIAR BRANCO & ASSOCIADOS / SIMOLDES / UNIV. DO MINHO / GRUPO AMORIM / PLMJ / FORESTIS  
LIGA PORTUGUESA CONTRA O CANCRO / GRUPO JERÓNIMO MARTINS / ABREU ADVOGADOS / C. M. CASCAIS

MULTI CONFERÊNCIA - MULTI PLATAFORMA - MULTI DISPOSITIVO  
ACEDA À SUA SALA ATRAVÉS DE:



# My Team TP200 Windows

The first windows 10 telepresence system, for any multi-technology meeting room.



Full HD  
1080

CÂMARA PTZ  
WINDOWS 10

PROCESSADOR I5, 64 GB, MICROFONE WIRELESS



Windows 10



COMPATÍVEL COM TODAS AS SOLUÇÕES DE VÍDEOCONFERÊNCIA NO MERCADO



# My Team 4k B&H Windows

It is exclusive. It's for your meetings.

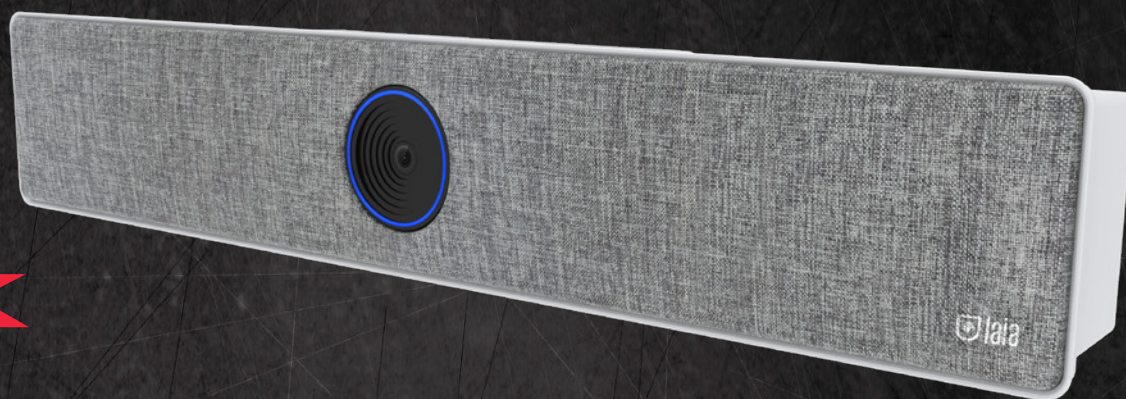

4K

CÂMARA COM PTZ E ZOOM DIGITAL  
ÂNGULO DE VISÃO WIDE 108°  
WINDOWS 10  
PROCESSADOR I5, 8 GB RAM  
2 X MICROFONE OMNI-DIRECIONAL  
COLUNA DE SOM INTEGRADA



Windows 10



## Cute B&H Lite

It's powerful, it's portable, it's Plug & Play



**CÂMARA PORTÁTIL ALL-IN-ONE**

**Full HD**  
1080



## Cute UP 4k B&H

Elegance and quality



**ePTZ ALL-IN-ONE SYSTEM**  
DUPLO MIC "BEAMFORMING" INTEGRADO  
ZOOM DIGITAL 4X  
COLUNA DE SOM INTEGRADA

**4K**



## Cute 4k

Designed for your organization



**4K PTZ CAMERA**  
SAIDA USB / HDMI  
ZOOM 12X

## Cute 4k AI

The camera that changes everything



**CÂMARA PORTÁTIL ALL-IN-ONE**  
DUPLO MIC INTEGRADO

**4K**



**4K**

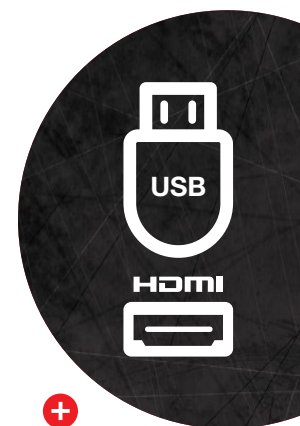

## T-Pod Trio



**MICROFONE DE MESA COM DISPLAY TOUCH**  
CONEXÃO USB E HDMI  
WIFI E ETHERNET

## T-Pod Airbone



**MICROFONE WIFI COM COLUNA E BASE**  
INCLUI BASE DE MESA PARA CARREGAMENTO  
IDEAL PARA DISTÂNCIAS ATÉ 6M

## T-Pod WiFi



**MICROFONE WIFI COM COLUNA**  
CONEXÃO WIFI VIA DONGLE USB  
IDEAL PARA DISTÂNCIAS ATÉ 6M

## T-Pod Dual



**DUPLO MICROFONE WIFI COM COLUNA**  
CONEXÃO WIFI VIA DONGLE USB

## T-Pod Quad



**QUATRO MICROFONES WIFI COM COLUNA**  
CONEXÃO WIFI VIA T-POD MASTER  
AUDIO INPUT / OUTPUT



## VC520+ CONFERENCE CAMERA

-----> 12X ZOOM ÓTICO PTZ CÂMARA  
260° PAN / 115° TILT / 82° DIAGONAL  
FULL HD 1080p



## VC320 CONFERENCE CAMERA

PORTÁTIL ALL-IN-ONE



-----> MICROFONE FULL DUPLEX  
COLUNA 10W / 95dBspl  
ATÉ 9M ALCANCE

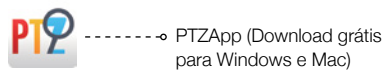

-----> INCLUI CONTROLO REMOTO  
ATÉ 10 PRESETS





**AVerVision F70W**

VISUALIZADOR DE DOCUMENTOS



**PTC500S**  
CONFERENCING CAM

30X OPTICAL ZOOM  
±175° PAN / -30°+90° TILT  
AUTO TRACKING



**AUTO TRACKING**  
**120° FOV**



**SVC100**  
VIDEO CONFERENCING

18X OPTICAL ZOOM  
±110° PAN / +25°-25° TILT / 82° FOV (DIAGONAL)  
MULTI-PONTO / SKYPE FOR BUSINESS  
GRAVAÇÃO DE DADOS, ÁUDIO E ANOTAÇÕES



**32 GB**  
MEMÓRIA INTERNA

**S40i**  
CHARGE / SYNC CARTS

ARMÁRIO PARA PORTÁTEIS / TABLETS  
TAMANHO MÁXIMO 14"  
VÁRIOS MODELOS DISPONÍVEIS



**CM340**  
HUDDLE ROOM COLLABORATION  
USB CAMERAS

PORTÁTIL ALL-IN-ONE  
CONFERENCE CAMERA



**reddot award 2018**  
winner



**Info** VÁRIOS PRODUTOS E  
OPÇÕES DISPONÍVEIS  
CONSULTE-NOS PARA  
MAIS INFORMAÇÕES



**+** AV Bridge Mini  
AV BRIDGES

**EXTEND IT  
BRIDGE IT  
STREAM IT**

INTEGRA FONTES AV NO  
SEU PC VIA USB 3.0

USA TECNOLOGIA  
HDBaseT

SAÍDA USB  
ATÉ 1080P / 60

# USB Collaboration AV Bridges Professional Cameras Controls & Switchers

**vaddio®**

## Tracking System

Ideal for classrooms or training rooms, Vaddio tracking systems let instructors focus on teaching, not technology.

**Ideal para salas de aula ou de reunião, o sistema de tracking Vaddio permite que os instrutores se foquem em ensinar e não na tecnologia.**



**RoboTRAK**  
Intelligent Tracking



VÁRIAS SOLUÇÕES E  
PRODUTOS DISPONÍVEIS  
CONSULTE-NOS PARA  
MAIS INFORMAÇÕES



**ConferenceSHOT™ AV**





**BEAMFORMING  
MICROPHONE ARRAY 2**

MICROPHONE ARRAY WITH BEAMFORMING  
AND ADAPTIVE STEERING.  
NEXT-GENERATION ACOUSTIC ECHO  
CANCELLATION AND NOISE CANCELLATION.

Boardrooms  
Conference Rooms  
Large Lecture Halls  
Training Centers  
Courtrooms  
Telemedicine Facilities  
Houses of Worship





# PROFESSIONAL AUDIO DSP MIXER

## AUDIO AND VIDEO COLLABORATION



**+**  
**CONVERGE® Huddle**

- EASY.** JUST ONE CABLE CONNECTION AWAY FROM AUDIO AND VIDEO COLLABORATION.
- PRO-QUALITY.** BUILT WITH CLEARONE'S NEXT GEN AEC, DISTRIBUTED ECHO CANCELLATION®, NOISE CANCELLATION, AND ACOUSTIC INTELLIGENCE.
- FLEXIBLE.** CHOOSE CLEARONE CAMERAS, MICS, AND SPEAKERS OR USE 3RD PARTY DEVICES.
- INTEGRATOR-FRIENDLY.** PRE-CONFIGURED TEMPLATE, AUTO-DISCOVERY, PRO CONSOLE® SOFTWARE.



**+**  
**CEILING MICROPHONE ARRAY ANALOG-X**

- RELIABLE.** FULL 360-DEGREE COVERAGE AND OPTIMIZED FOR SPEECH-INTELLIGIBILITY FOR BETTER COMMUNICATION.
- SIMPLE.** ABILITY TO DAISY-CHAIN UP TO 4 MIC ARRAYS FOR EASY INSTALLATION.
- PRO-QUALITY.** WIDE BANDWIDTH AND HIGH SNR FOR SUPERIOR AUDIO QUALITY.
- FLEXIBLE.** CAN BE USED WITH CLEARONE DSP MIXERS OR ANY 3RD PARTY MIXER

# FULL 360° COVERAGE





## Gen3Pod

Plataforma colaborativa para qualquer espaço  
 Transforme e aumente a sua produtividade

### KEY FEATURES //

- UNLIMITED NUMBER OF USERS
- UNLIMITED NUMBER OF POSTS ON-SCREEN
- CONNECT VIA WI /ETHERNET NETWORKS
- MULTI-ROOM COLLABORATION
- HD-QUALITY VIDEO STREAMING
- IOS AND ANDROID MIRRORING
- MODERATOR PREVIEW & CONTROL
- CUSTOMIZABLE LAYOUTS
- TOUCHSCREEN COMPATIBLE
- CENTRALIZED MANAGEMENT DASHBOARD
- ENTERPRISE-GRADE NETWORK SECURITY
- DIGITAL SIGNAGE
- ANNOTATION
- ROOM BOOKING

### best-in-class wireless display solution //

- CONFERENCE ROOMS
- CLASSROOM COLLABORATION
- INFORMAL HUDDLE SPACES
- COMMAND & CONTROL
- DATA VISUALIZATION
- DIGITAL SIGNAGE



OVER 4K HAPPY CUSTOMERS



### MULTIPLE USERS

TODOS PODEM COMPARTILHAR E CONTROLAR O CONTEÚDO DE FORMA COLABORATIVA.



### ANY AMOUNT OF CONTENT

PARTILHA EM SIMULTÂNEO DE QUALQUER TIPO E QUANTIDADE DE CONTEÚDO. (DESKTOP, APP WINDOWS, MEDIA FILES, ETC...)



### BYOD

SOLSTICE SUPORTA ANDROID, IOS, WINDOWS, MAC OS X DEVICES AND CHROMECAST.



### EASY TO USE

DESDE A PRIMEIRA CONEXÃO, OFERECE UMA EXPERIÊNCIA DE USUÁRIO INTUITIVA.





**MERCURY™**

TABLE TOP CONFERENCE SYSTEM  
TODOS OS RECURSOS NUM ÚNICO DISPOSITIVO.

TRANSFORME A SUA SALA DE AULA OU DE REUNIÕES  
EM ESPAÇOS COLABORATIVOS

**SISTEMAS INTEGRADOS DE AUDIOVISUAIS E ILUMINAÇÃO**



**AIR Media™**

COMPLETA SOLUÇÃO WIRELESS  
DE APRESENTAÇÃO HD, A PARTIR  
DE QUALQUER PLATAFORMA OU  
DISPOSITIVO MÓVEL. (IOS / ANDROID)



# GRAVAÇÃO E STREAMING

AN END-TO-END SOLUTION FOR RECORDING AV PRESENTATIONS FROM SCHEDULING TO LIVE STREAMING AND PUBLISHING



COMO GRAVAR E FAZER STREAMING EM TEMPO REAL?  
CONSEGUIMOS PESQUISAR POR TÍTULO, DATA, AUTOR?  
COMO ARQUIVAR OS FICHEIROS?

**A GAMA SMP300 DÁ RESPOSTA A TODAS AS SUAS PERGUNTAS!**



## SMP 300 Series

**Extron SMP 351**  
Streaming Media Processor

EXEMPLO DO DIAGRAMA DE LIGAÇÕES

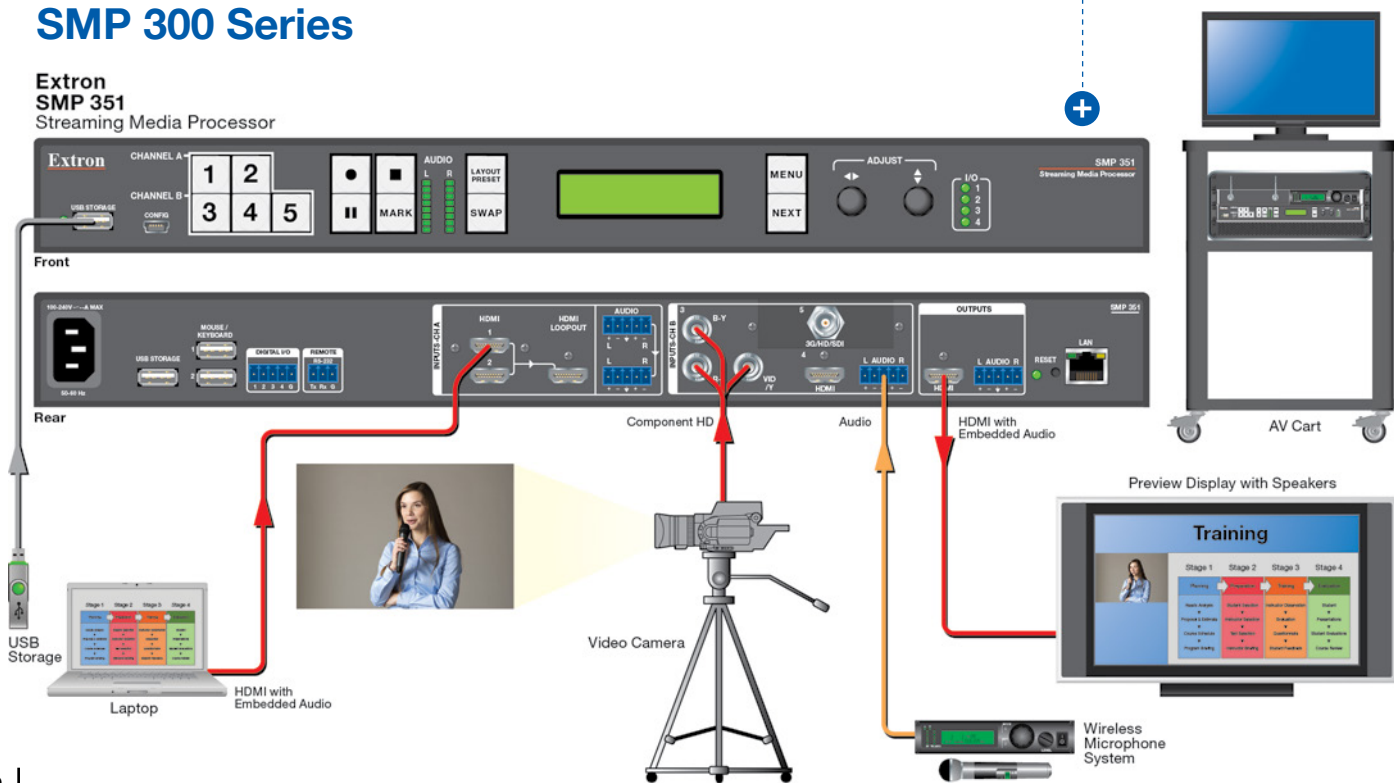

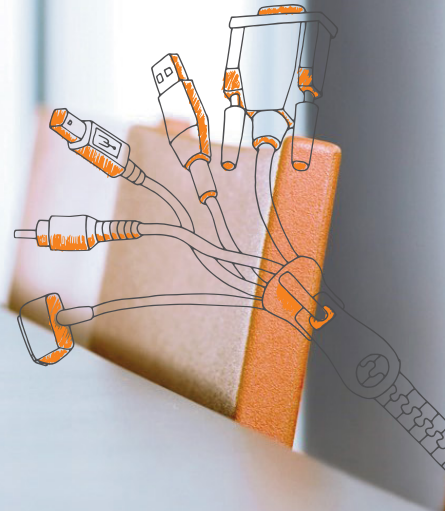

4" | 7" | 10"

Neets TOUCH PANEL™

COMPATÍVEL COM:  
SIERRA II, TANGO, ALFA II, DELTA AND LIMA.  
DISPONÍVEL EM PRETO, BRANCO (7")

**MAKE LIFE EASIER  
FOR PRESENTERS**  
with one simple touch

## WE BRING YOUR MESSAGE TO LIFE



### Neets Sound Bar - SB1

4X 20W (RMS) | AMPLIFICADOR INTEGRADO COM DSP | AUTO ON/OFF COM ENTRADA DE SINAL SEM NECESSIDADE DE COMANDO REMOTO RS232 PARA POSSIBILIDADE DE CONTROLO | ENTRADAS DE ÁUDIO DIGITAL E ANALÓGICA  
CONSTRUÇÃO EM MDF | POSSIBILIDADE DE INSTALAÇÃO EM PAREDE OU EM BASE DE MESA

DISPONÍVEL EM 5 CORES +



### Neets MiniConnect MC1

CAIXA DE MESA QUE PERMITE CONECTAR DE UM A TRÊS CABOS  
PODE PERSONALIZAR A CONETIVIDADE PARA ATENDER ÀS  
NECESSIDADES DA SALA



### Neets Uniform

INTERFACE DE CONTROLO AV  
PODE SER PERSONALIZADO E CONFIGURADO ATÉ 8 BOTÕES  
PARA QUALQUER FUNÇÃO INDEPENDENTEMENTE DA SALA E  
EQUIPAMENTO ESCOLHIDOS.

# 08. GESTÃO DE SINAL DIGITAL



**WyreStorm**

**Info** VÁRIAS SOLUÇÕES E  
PRODUTOS DISPONÍVEIS  
CONSULTE-NOS PARA  
MAIS INFORMAÇÕES





**USADO PARA PEQUENAS SALAS**  
INSTALAÇÕES ATÉ 15M  
IDEAL PARA SINAL DE TRANSMISSÃO AV  
PLUG & PLAY AV SOLUTION



**CAPAZ DAS MAIORES INSTALAÇÕES**  
FIÁVEL E ALTAMENTE ESCALÁVEL  
SUPPORTA 1080P 60HZ E 1920X1200 SEM PERDAS  
CONFIGURAÇÃO MODULAR, FÁCIL DE EXPANDIR



**USADO PARA GRANDES INSTALAÇÕES**  
ATÉ 100M  
SUPPORTA RESOLUÇÕES 4K  
GRANDE LARGURA DE BANDA



**SOLUÇÃO DE CONTROLO IP, ESCALÁVEL**  
CONECTIVIDADE ETHERNET  
INTERFACE MULTI PLATAFORMA  
COMPATÍVEL COM QUALQUER DISPOSITIVO

**KIT EXTENSOR DE SINAL HDMI**  
EX-35-H2



BIDIRECIONAL  
IR E RS-232  
POH  
HDCP 2.2

4K	1080P
35M	70M

**TRANSMISSOR DE PAREDE / CHÃO**  
TX-SW-IW-0201



HDMI/VGA  
ATRAVÉS HDBaseT  
TRANSMITE ATÉ 100m (1080p)

4K	INPUT	OUTPUT
	2	1

# SALAS DE AULAS | FORMAÇÃO | AUDITÓRIOS

**SWITCHER / ESCALADOR**  
SW-0501-HDBT



INPUT	OUTPUT
5	1+1

SCREENLINK

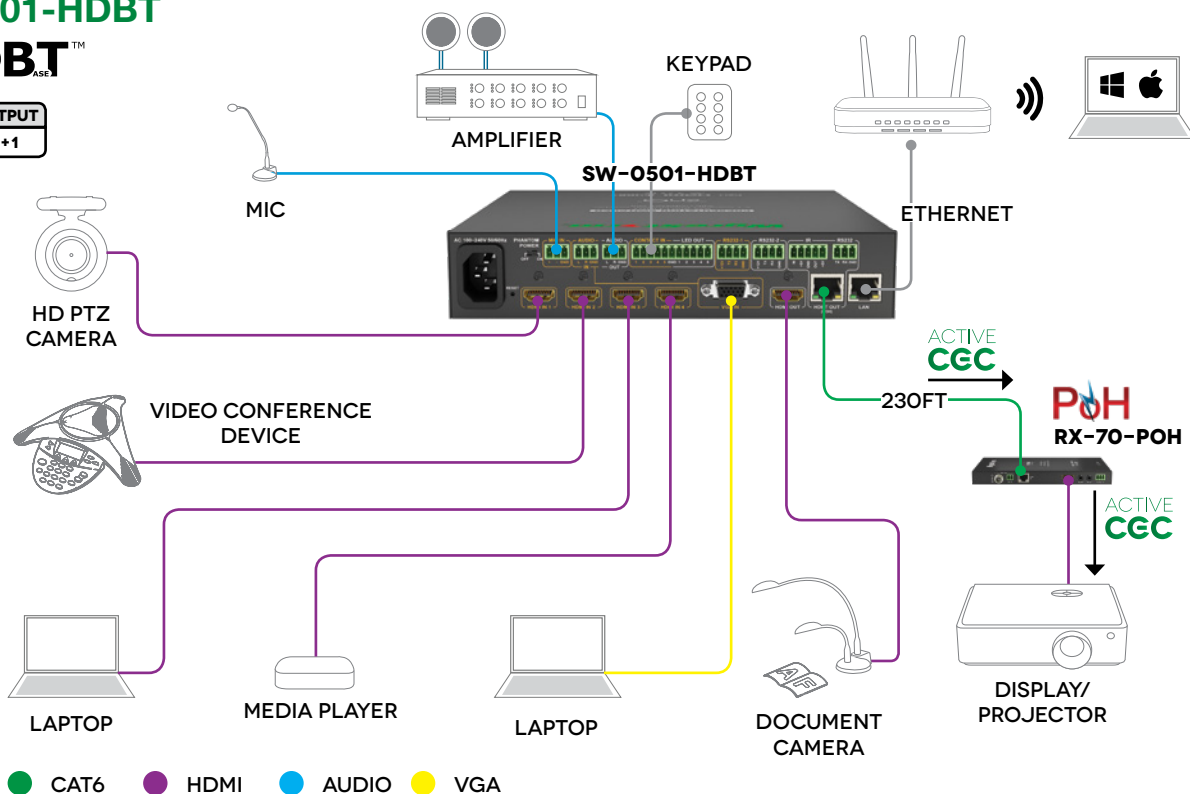

EXEMPLO DIAGRAMA DE LIGAÇÕES A UM SW-0501-HDBT

# 09. VÍDEO PROFISSIONAL

## PROFISSIONAL CAMCORDERERS

Panasonic | SONY | Blackmagicdesign

AMPLA GAMA DE CÂMARAS DE MÃO PARA VÍDEO PROFISSIONAL



## TRIPÉS / ILUMINAÇÃO

COMPACTOS, LEVES E PORTÁTEIS

## INTERCOM

SISTEMAS DE INTERCOMUNICAÇÃO



**Info** VÁRIAS SOLUÇÕES E PRODUTOS DISPONÍVEIS  
CONSULTE-NOS PARA MAIS INFORMAÇÕES

## CAPTAÇÃO / STREAMING

SISTEMA COMPLETO DE CAPTAÇÃO E STREAMING  
KIT ALL-IN-ONE

## GESTÃO DE TEMPOS

SOFTWARE DE GESTÃO DE TEMPOS  
O SEU CONTADOR DIGITAL

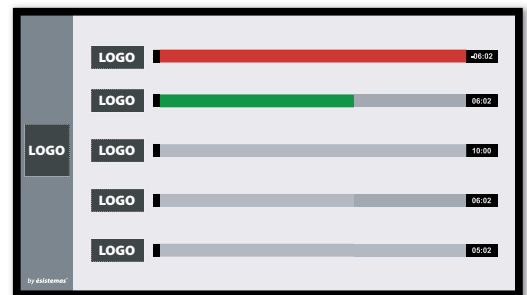

GESTÃO EM BACK OFFICE



**Info** VÁRIAS SOLUÇÕES E PRODUTOS DISPONÍVEIS  
CONSULTE-NOS PARA MAIS INFORMAÇÕES

# SISTEMAS DE PRODUÇÃO DE VÍDEO



**Info** VÁRIAS SOLUÇÕES E PRODUTOS DISPONÍVEIS  
CONSULTE-NOS PARA MAIS INFORMAÇÕES



## ÁUDIO PORTÁTIL

### VOYAGER

COLUNA / AMPLIFICADOR PORTÁTIL  
COM COMANDO À DISTÂNCIA,  
BLUETOOTH E MICROFONE DE MÃO WIRELESS

Ideal para  
apresentações

Bluetooth®



**TODOS OS MODELOS**  
INCLUEM RODAS E PEGA  
PARA FÁCIL TRANSPORTE

### BT15 PRO

POTÊNCIA 500W  
DIMENSÕES 430X812X415MM



**TODOS OS MODELOS**  
INCLUEM 2 MICROFONES  
DE MÃO WIRELESS



### BT10

POTÊNCIA 250W  
DIMENSÕES 265X445X280MM



### BT12

POTÊNCIA 350W  
DIMENSÕES 350X565X320MM



### BT15

POTÊNCIA 450W  
DIMENSÕES 480X735X420MM

## CABLAGEM

### OFCFR

CABOS DE COLUNA AMC®  
DISPONÍVEIS EM DIÂMETRO:  
2X0,82MM<sup>2</sup> / 2X1,5MM<sup>2</sup> (BOBINES DE 100M)

CINZA LARANJA



### PROCAB

AMPLA GAMA DE CABOS  
ÁUDIO | VÍDEO | DATA | POWER  
DISPONÍVEIS EM BOBINES OU PRÉ-FEITO



WIRELESS SYSTEMS **MICROFONES**



**Perception Wireless**

**SISTEMA DE MICROFONES SEM FIOS**  
 FREQUÊNCIA ÁUDIO 40 - 20.000HZ  
 8 CANAIS SELECIONÁVEIS  
 3 MODELOS DISPONÍVEIS

**LIBERTE-SE!** SOM AO VIVO, APRESENTAÇÕES, FORMAÇÕES

**Info** VÁRIOS MODELOS E OPÇÕES DISPONÍVEIS  
 CONSULTE-NOS PARA MAIS INFORMAÇÕES



**WMS420**

**SISTEMA DE MICROFONES SEM FIOS**  
 FREQUÊNCIA ÁUDIO 40 - 20.000HZ  
 8 CANAIS SELECIONÁVEIS  
 3 MODELOS DISPONÍVEIS

VOCAL **MICROFONE DE CABO**

**D5**  
**MICROFONE DE MÃO**  
 SUPERCARDIOID  
 ÁUDIO BALANCEADO XLR  
 FREQUÊNCIA 70 - 20.000HZ



APENAS 320GRMS **+**

TABLETOP **MICROFONE DE ORADOR**

**CGN521STS**  
**MICROFONE DE MESA GOOSENECK**  
 CARDIOID  
 ÁUDIO BALANCEADO XLR  
 FREQUÊNCIA 70 - 18.000HZ  
 ALIMENTAÇÃO PHANTOM POWER  
 INCLUI BASE DE MESA + MICRO DE 50CM



PODE SER PROGRAMADO COM VÁRIAS FUNÇÕES **+**

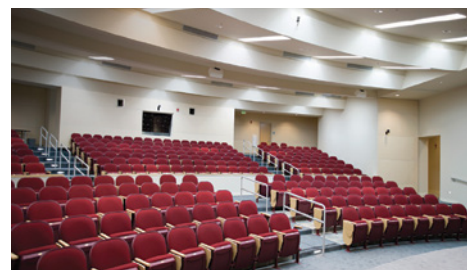

## PC 5X / 8X

### COLUNAS DE ENCASTRAR DE TETO PASSIVAS

POTÊNCIA 20W (PC 5X) 40W (PC 8X)  
 IMPEDÂNCIA 8 OHMS  
 DIMENSÕES Ø190MM X 80MM (PC 5X)  
 DIMENSÕES Ø274MM X 105MM (PC 8X)



W  
RAL 9016

## PowerBox 5

### COLUNAS DE PAREDE ATIVAS

POTÊNCIA (2X20W)  
 FREQUÊNCIA RESPOSTA 80 HZ - 20 KHZ  
 INPUTS: 1 X STEREO RCA, 1 X 3.5MM JACK



B W  
RAL 9017 RAL 9016

INCLUI SUPORTES

## VIVA 4 / 5

### COLUNAS DE PAREDE PASSIVAS

POTÊNCIA 20W (VIVA 4) 30W (VIVA 5)  
 IMPEDÂNCIA 8 OHMS  
 DIMENSÕES 205 X 188 X 132MM (VIVA 4)  
 DIMENSÕES 245 X 175 X 170MM (VIVA 5)  
 INCLUI SUPORTES



B W  
RAL 9017 RAL 9016

## PowerBox 5HP

### COLUNAS DE PAREDE ATIVAS

POTÊNCIA (2X20W)  
 FREQUÊNCIA RESPOSTA 115 HZ - 20 KHZ  
 INPUTS: 1 X 3.5MM JACK



W  
RAL 9003

INCLUI COMANDO E SUPORTES



SUPORTES DE ENCASTRAR  
 Ver Página 45

## MA 30X

### AMPLIFICADOR ÁUDIO

POTÊNCIA (30W)  
 FREQUÊNCIA RESPOSTA 50 HZ - 20 KHZ  
 DIMENSÕES 320X190X75MM  
 INPUTS: 2 X MIC JACK 6.3MM, 2 X RCA



B  
RAL 9017

## iCOMC 2x20

### MINI AMPLIFICADOR ÁUDIO DE 2 CANAIS

POTÊNCIA 2X20W  
 FREQUÊNCIA RESPOSTA 35 HZ - 20 KHZ  
 DIMENSÕES 145 X 120 X 45MM  
 INTERFACE RS232, COMANDO IR OPCIONAL



Info VÁRIOS MODELOS E OPÇÕES DISPONÍVEIS  
 CONSULTE-NOS PARA MAIS INFORMAÇÕES

## TCB1

### CAIXA DE LIGAÇÕES DE MESA

INCLUI 2 TOMADAS EUROPEIAS  
 9 SLOTS DISPONÍVEIS PARA CABOS  
 DIMENSÕES 136 X 170 X 150MM



B  
AÇO + ALUMÍNIO ANODIZADO

## ACESSÓRIOS PARA INSTALAÇÕES

### TECHCONNECT

CAIXAS DE LIGAÇÕES PARA INSTALAÇÕES AV  
VÁRIOS MODELOS E CONFIGURAÇÕES DISPONÍVEIS



VÁRIAS CAIXAS  
DISPONÍVEIS



CABOS TECHCONNECT PARA CAIXAS VISION  
RÁPIDA CONEXÃO AO MÓDULO



### TC2-VGAHDMI2

ADAPTADOR / CONVERSOR VGA PARA HDMI  
CONVERTE O SINAL ANALÓGICO EM SINAL DIGITAL



VÁRIOS MODELOS  
DISPONÍVEIS



### TC3-AMP

AMPLIFICADOR DIGITAL 2 X 25W (RMS) 8 OHMS  
2 ENTRADAS STÉREO



INCLUI COMANDO

### TC3-CTL

MÓDULO UNIVERSAL DE CONTROLO  
VIA IR, RS-232, RS-485. 12V. | COMANDOS PROGRAMÁVEIS



ALIMENTADO POR ADAPTADOR  
DE CORRENTE OU PILHAS

ELIMINE  
OS SEUS  
COMANDOS  
TC3-CTL

## ATEN

### VS92A

VIDEO SPLITTER VGA 350 MHZ  
1 VGA IN / 2 VGA OUT



MAX. 30M  
COMPRIMENTO

### CS84U

DESKTOP KVM SWITCH  
4-PORT PS / 2-USB VGA KVM SWITCH



### VS381

SWITCH HDMI  
3 HDMI IN / 1 HDMI OUT



INCLUI  
COMANDO

## BASTIDOR AV

ARMÁRIOS / FLIGHT CASES

### Racks 19"

ARMÁRIOS RACK DE 19" METÁLICOS  
CONSULTE-NOS PARA OUTROS TAMANHOS

VÁRIOS MODELOS  
DISPONÍVEIS



## AIR MOUSE

APRESENTAÇÕES

### Elite

IDEAL PARA APRESENTAÇÕES  
WIRELESS, DISTÂNCIA MÁXIMA ATÉ 30M  
COMPATÍVEL COM WINDOWS / MAC



Gyratation



BATERIA  
RECARREGÁVEL

### UH3234

DOCK MULTI-PORT USB-C  
ATÉ 10 DISPOSITIVOS



## CONFIDEA WIRELESS CONFERENCE SYSTEM

### SOFTWARE TRANSCRIÇÃO DE FALA

TRANSFORME UMA  
GRAVAÇÃO DE ÁUDIO  
DIGITAL NUM FICHEIRO  
DE TEXTO



MEDIA FILE



PROCESSING



XML METADATA

CONSULTE-NOS PARA MAIS INFORMAÇÕES



CONFIDEA  
WIRELESS G3

PLIXUS OFERECE MAIS LARGURA DE BANDA, MELHOR QUALIDADE E MENOS TEMPO DE ESPERA DO QUE QUALQUER OUTRA TECNOLOGIA DE REDE COMERCIAL



D-CERNO  
COM OU SEM GRAVAÇÃO USB



# FORMA & FUNÇÃO

## CONFERÊNCIAS INTERATIVAS E FLEXÍVEIS

### uniCOS 10" Tabletop Unit



#### UNICOS

##### COMPACTO

OCUPAR O MENOR ESPAÇO POSSÍVEL

##### POWER OVER ETHERNET

ALIMENTADOS PELO MESMO CABO CAT QUE ALIMENTA TUDO O RESTO DA REDE PLIXUS®

##### CAMERA INTEGRADA

PARA GARANTIR UMA VISÃO PERFEITA DO PARTICIPANTE POR TRÁS DO DISPOSITIVO

##### PRESIDENTE OU DELEGADO

PODE SER CONFIGURADO PARA FUNCIONAR COMO DISPOSITIVO DE PRESIDENTE OU DE DELEGADO

##### PORTAS USB INCLUÍDAS

CARREGUE O SEU TELEFONE OU SIMPLEMENTE CONECTE A PLAQUETA DE IDENTIFICAÇÃO PLIXUS, GRAÇAS ÀS DUAS PORTAS USB

PLIXUS OFERECE MAIS LARGURA DE BANDA, MELHOR QUALIDADE E MENOS TEMPO DE ESPERA DO QUE QUALQUER OUTRA TECNOLOGIA DE REDE COMERCIAL



3 MODELOS DISPONÍVEIS | UNICOS 7" & 10" FLUSHMOUNT E UNICOS 10" TABLETOP  
CONSULTE-NOS PARA MAIS INFORMAÇÕES



DISPLAY INCLINÁVEL  
7 POSIÇÕES AJUSTÁVEIS



**BASE DE TETO**  
INCLUI TAMPA DECORATIVA

**COLUNA EXTENSÍVEL**  
3 TAMANHOS | 30-45CM, 45-80CM, 80-135CM



11 KG  
MAX

B

W

all in one  
solution  
**PIN CONNECT  
PROJECTOR MOUNT**

**SUPORTE**  
PARA FIXAÇÃO DO VÍDEOPROJETOR

## SHORT THROW ULTRA SHORT THROW



**WM210AUS / 220 / 230**

**SUPORTE UNIVERSAL DE PAREDE, DUPLA BASE**  
3 MODELOS DISPONÍVEIS  
COMPRIMENTO AJUSTÁVEL  
ATÉ 495mm / 768mm / 1382mm

## LARGE FORMAT DISPLAYS

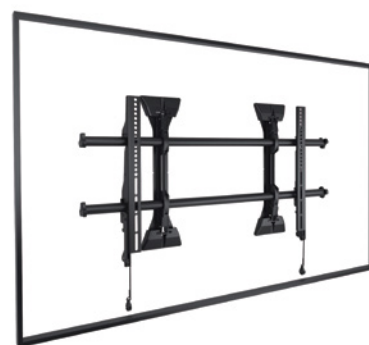

**LSM1U**

**SUPORTE UNIVERSAL DE PAREDE**  
COMPATÍVEL COM DISPLAYS DE 37" a 63"  
MÁXIMO VESA 880 x 500mm  
VÁRIOS MODELOS E OPÇÕES DISPONÍVEIS

DISPLAY  
63" MAX

B

**XSM1U**

**SUPORTE UNIVERSAL DE PAREDE**  
COMPATÍVEL COM DISPLAYS DE 55" a 82"  
MÁXIMO VESA 1070 x 600mm  
VÁRIOS MODELOS E OPÇÕES DISPONÍVEIS

DISPLAY  
82" MAX

B

VÁRIAS  
SOLUÇÕES  
PARA  
MÚLTIPLOS  
DISPLAYS

+ LCM2X1U



DISPLAY  
80" MAX

B

S

**MPAU**

**SUPORTE UNIVERSAL DE CHÃO COM RODAS**  
COMPATÍVEL COM DISPLAYS DE 37" a 55"  
MÁXIMO VESA 600 x 400mm  
ALTURA AJUSTÁVEL (127-177cm)  
VÁRIOS MODELOS E OPÇÕES DISPONÍVEIS

**LPAU**

**SUPORTE UNIVERSAL DE CHÃO COM RODAS**  
COMPATÍVEL COM DISPLAYS DE 40" a 80"  
MÁXIMO VESA 800 x 400mm  
ALTURA AJUSTÁVEL (127-177cm)  
VÁRIOS MODELOS E OPÇÕES DISPONÍVEIS



**MFAU**

**SUPORTE UNIVERSAL DE CHÃO FIXO**  
COMPATÍVEL COM DISPLAYS DE 37" a 55"  
MÁXIMO VESA 600 x 400mm  
ALTURA AJUSTÁVEL (113-163cm)  
VÁRIOS MODELOS E OPÇÕES DISPONÍVEIS

**LFAU**

**SUPORTE UNIVERSAL DE CHÃO FIXO**  
COMPATÍVEL COM DISPLAYS DE 40" a 80"  
MÁXIMO VESA 800 x 400mm  
ALTURA AJUSTÁVEL (113-163cm)  
VÁRIOS MODELOS E OPÇÕES DISPONÍVEIS



VÁRIOS MODELOS E PRODUTOS DISPONÍVEIS  
CONSULTE-NOS PARA MAIS INFORMAÇÕES

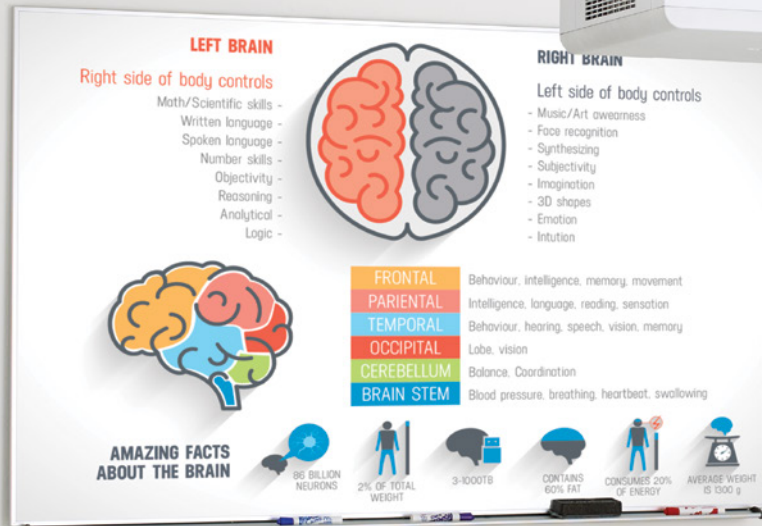

**CHIEF® KIT SERIES**  
JÁ INCLUI SUPORTE, COLUNA  
AJUSTÁVEL E BASE DE TETO  
2 CORES | 3 TAMANHOS

**KITEC030045**  
COLUNA 30-45CM

**KITEC045080**  
COLUNA 45-80CM

**KITEC080135**  
COLUNA 80-135CM



**QUADROS DE PORCELANA - MATERIAL DIDÁTICO**  
Página 47

as melhores  
soluções para  
salas de aula  
e de formação



**MOBILE CART STAND**  
FUSION DYNAMIC  
HEIGHT ADJUSTABLE



**DISPLAYS**  
Página 15



VÁRIAS SOLUÇÕES E  
PRODUTOS DISPONÍVEIS  
CONSULTE-NOS PARA  
MAIS INFORMAÇÕES

## PROJECTOR / DISPLAY MOUNT SOLUTIONS VÍDEOPROJETOR / DISPLAYS



20KG  
MAX

### 340W

**SUPORTE UNIVERSAL DE TETO**  
ALTURA FIXA DE 12CM  
TILT +15° -15° | ROTAÇÃO 90°

Branco



20KG  
MAX

### 350S/W

**SUPORTE UNIVERSAL DE TETO**  
BRAÇO EXTENSÍVEL DE 43 A 65CM  
TILT +5° -5°, ROTAÇÃO 90°, (12CM SEM BRAÇO)

Silver

Branco



16KG  
MAX

### GA750

**SUPORTE UNIVERSAL DE PAREDE**  
**IDEAL PARA PROJETORES DE CURTA DISTÂNCIA**  
AJUSTÁVEL DE 22,5 A 75CM

Preto



VESA  
600x400



DISPLAY  
70" MAX

### 295

**SUPORTE UNIVERSAL DE CHÃO COM RODAS**  
COMPATÍVEL COM DISPLAYS DE 32" a 70"  
ALTURA AJUSTÁVEL DE 120 A 180CM.  
INCLUI PRATELEIRA EM VIDRO.

Silver / Preto



VESA  
600x400



DISPLAY  
70" MAX

IDEAL PARA  
VIDEO  
CONFERÊNCIA

### VWA1125

**SUPORTE UNIVERSAL DE CHÃO COM RODAS**  
COMPATÍVEL COM DISPLAYS DE 37" a 70"  
ALTURA AJUSTÁVEL DE 120 A 160CM.  
INCLUI 2 PRATELEIRAS.

Silver / Preto



VESA  
1000x600



DISPLAY  
100" MAX

### VWA1130

**SUPORTE UNIVERSAL DE CHÃO COM RODAS**  
COMPATÍVEL COM DISPLAYS DE 60" a 100"  
ALTURA AJUSTÁVEL DE 120 A 165CM.  
INCLUI 2 PRATELEIRAS.

Silver / Preto



VESA  
600x400

### 040

**SUPORTE UNIVERSAL DE PAREDE**  
COMPATÍVEL COM DISPLAYS DE 37" a 90"  
TILT +0° -10°

Preto



VESA  
400x400

### WM420T

**SUPORTE UNIVERSAL DE PAREDE**  
COMPATÍVEL COM DISPLAYS DE 32" a 65"  
TILT +0° -10°, ROTAÇÃO 180°, LEVELING +5° -5°

Preto



VESA  
600x400

### 275

**SUPORTE UNIVERSAL DE PAREDE**  
COMPATÍVEL COM DISPLAYS DE 37" a 70"  
TILT +5° -15°, ROTAÇÃO 120°, SWIVEL +3° -3°

Preto

**AUTOMATED PROJECTOR LIFT**  
SOLUÇÕES DE ENCASTRAR MOTORIZADAS

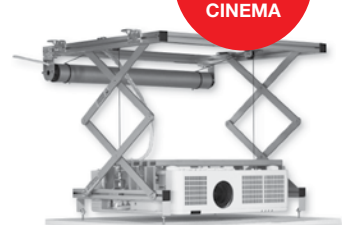
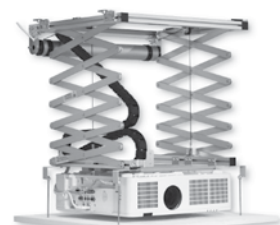
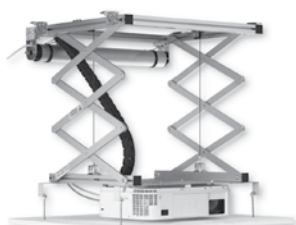
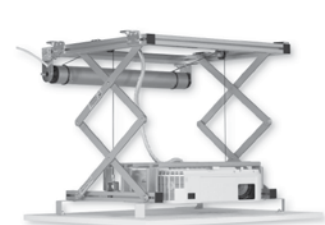

**SI-30**

**SI-100**

**SI-200**

**SI-H L 100**

**SI-H L 200**

**SI-H L 40 HC**

13cm  
Altura Mínima

16cm  
Altura Mínima

24cm  
Altura Mínima

15,5cm  
Altura Mínima

25,5cm  
Altura Mínima

14cm  
Altura Mínima

48cm  
Descida MAX

97cm  
Descida MAX

196cm  
Descida MAX

97cm  
Descida MAX

197cm  
Descida MAX

54cm  
Descida MAX

15 KG  
MAX

15 KG  
MAX

15 KG  
MAX

30 KG  
MAX

30 KG  
MAX

30 KG  
MAX

FECHADO



ABERTO



VÁRIOS MODELOS E  
PRODUTOS DISPONÍVEIS  
CONSULTE-NOS PARA  
MAIS INFORMAÇÕES

## MONITOR MOUNT

### GAMA DESKTOP / MULTI MONITORES



DM2200



DM3200

VÁRIOS  
MODELOS  
PARA  
MÚLTIPLOS  
DISPLAYS



IMAGEM NAPOFIX® \*DM3100 DESK MOUNT

### ERGO100

BASE ERGONÓMICA PARA PORTÁTIL ATÉ 17"  
TILT +14° -14° | MAX. 18 KG



### ERGO110

BASE ERGONÓMICA PARA MONITOR  
MAX. 20 KG



### MPM001

SUPORTE PARA PEQUENOS CPU'S  
VESA 50X50 ATÉ 100X100 | MAX. 5 KG



### PT-ACRILICO

PÚLPITO DE ORADOR EM ACRÍLICO  
TRANSPARENTE COM INCLINAÇÃO REGULÁVEL  
ALTURA DE 120CM



**+** VÁRIAS OPÇÕES DISPONÍVEIS

### RD-3070

PÚLPITO DE ORADOR ROCADA  
ESTRUTURA CROMADA | VIDRO TEMPERADO 8MM  
AJUSTÁVEL EM ALTURA: 105-145CM



### PT-6A

PÚLPITO / MESA DE PROJEÇÃO  
TILT +35° -35° | MAX. 10 KG  
AJUSTÁVEL EM ALTURA: 70-110CM



### ED1M1500W / B

SECRETÁRIA ELÉTRICA  
AJUSTE EM ALTURA ELÉTRICO: 730-123CM  
AJUSTE EM LARGURA: 100-160CM



### ELETRIC DESK



**+** DISPONÍVEL EM DUAS CORES  
NÃO INCLUI TAMPO

### PT-5A

MESA DE PROJEÇÃO  
TILT +35° -35° | MAX. 10 KG  
AJUSTÁVEL EM ALTURA: 70-110CM





## AMPLA GAMA DE MOBILIÁRIO

RESPONDER ÀS NECESSIDADES DAS SALAS DE AULA NO ENSINO BÁSICO, SECUNDÁRIO E ACADÉMICO ASSIM COMO EM SALAS DE FORMAÇÃO E AUDITÓRIOS.



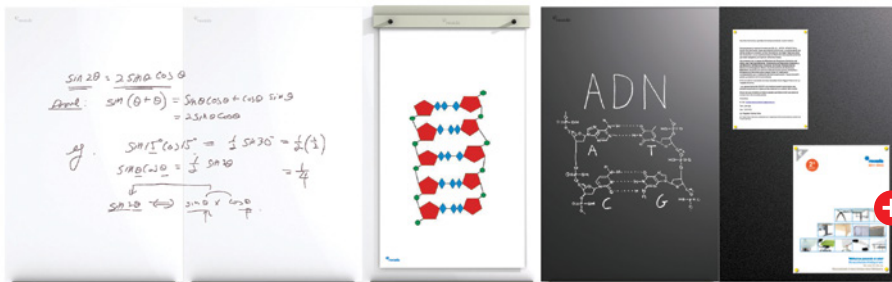

SkinWhiteBoard®  
*unlimited whiteboard*

**QUADROS DE ESCRITA ROCADA®**

COMBINAÇÕES SEM LIMITES  
PARA ESCRITA A MARCADORES  
VÁRIOS MODELOS E OPÇÕES DISPONÍVEIS

Branco Preto



**QUADROS DE PORCELANA**

PARA ESCRITA A MARCADORES  
CAIXILHARIA EM ALUMÍNIO  
VÁRIOS FORMATOS / ACABAMENTOS  
DISPONÍVEIS DE 45x60cm / 120x500cm

Branca Verde Preta

**QUADROS DE CORTIÇA / FORRADOS A TECIDO**

VÁRIOS FORMATOS / ACABAMENTOS  
DISPONÍVEIS DE 45x60cm / 120x500cm

Verde Cinza Azul Bordeaux

**MARCADORES**

Para usar em quadros brancos ou de vidro.  
Caixa 10 Unid.



**SUPORTE**

Magnético para quadros.  
Caixa 1 Unid.



**APAGADOR**

Feltro Magnético.  
Caixa 1 Unid.



**RECARGAS**

Feltro.  
Caixa 10 Unid.



# 14. CONTRATOS MANUTENÇÃO



## SERVIÇOS DE VALOR ACRESCENTADO

DISPOMOS DE SERVIÇOS DE ASSISTÊNCIA TÉCNICA E MANUTENÇÃO DE EQUIPAMENTOS, À MEDIDA DAS SUAS NECESSIDADES.



OS NOSSOS SERVIÇOS CONTEMPLAM UMA CRIAÇÃO DE SISTEMAS DE CONTROLO DE MANUTENÇÕES PREVENTIVAS E CORRETIVAS, PLANEADAS OU NÃO.

ESTAS AÇÕES SÃO EXECUTADAS ATRAVÉS DE INSPEÇÕES PLANEADAS, SISTEMÁTICAS, DETEÇÃO E MEDIDAS NECESSÁRIAS PARA EVITAR FALHAS INCIPIENTES COM A FINALIDADE DE CONSERVAR UM ITEM OU EQUIPAMENTO DENTRO DAS EXPECTATIVAS.



PODEMOS DAR RESPOSTAS DEPENDENDO DA LOCALIZAÇÃO E CONTRATO, ATÉ 72 HORAS COM TROCA DE EQUIPAMENTO INCLUÍDO.

**PROLONGAR O TEMPO DE VIDA ÚTIL DOS EQUIPAMENTOS**

REDUÇÃO DE CUSTOS OPERACIONAIS



**RELATÓRIOS DETALHADOS DE TODAS AS INTERVENÇÕES**

VÁRIOS NÍVEIS DE SERVIÇOS



**DESLOCAÇÕES INCLUÍDAS SEM CUSTOS ADICIONAIS**

CONTRATOS DE MANUTENÇÃO

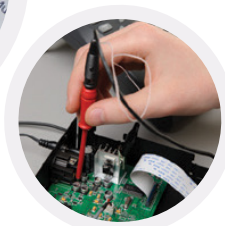
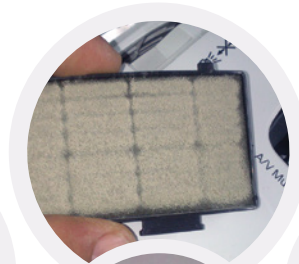
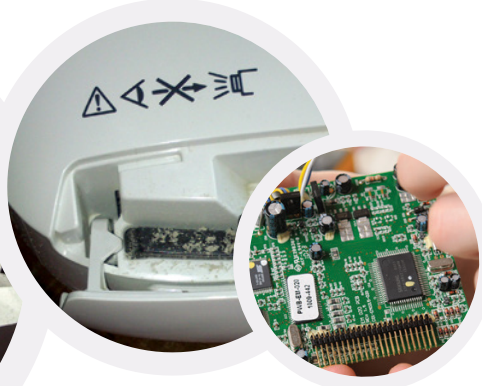

VÁRIOS SERVIÇOS DISPONÍVEIS  
CONSULTE-NOS PARA MAIS INFORMAÇÕES







COMPLETE CLASSROOM SOLUTIONS  
PRESENTATION & COLLABORATION  
VIDEOPROJECTION & LARGE FORMAT DISPLAYS  
PROFESSIONAL MOUNTS · PRO AUDIO & PRO VIDEO  
VIDEOCONFERENCE WEBCAST & STREAMING  
LECTURE CAPTURE · DIGITAL SIGNAGE · MULTIMEDIA KIOSKS  
INTERACTIVE TECHNOLOGIES  
SIGNAL MANAGEMENT, DISTRIBUTION AND ROUTING  
CONTROL & AUTOMATION  
SPECIALIZED TECHNICAL INSTALLATIONS  
AV PROJECTS CONSULTING

**new year  
new solutions**

*Catalog*

**education solutions**

**19.20**

TODAS AS CATEGORIAS DE PRODUTOS SÃO SUJEITAS A ALTERAÇÕES SEM AVISO PRÉVIO.  
A RESERVAÇÃO É OBRIGATORIA POR CADA QUANTIDADE INDIVIDUAL.

**é** SISTEMAS<sup>®</sup>  
VISUAL COMMUNICATION SOLUTIONS  
MULTIMEDIA PRODUCTS

[esistemas.pt](http://esistemas.pt)