

Specifications

Main unit

Power supply		AC 100-240V, 50Hz/60Hz (Taiwan:110V, 60Hz)	
Power consumption ¹	Maximum power consumption		480 W (500 VA)
	On-mode power consumption (Operating mode)	[Normal]	390 W * Operating Temperature: 25 °C (77 °F), Altitude: 700 m (2,297 ft), HDMI input All White (1920*1200@60) no other input, Picture mode: Standard, Dynamic Contrast [2]
		[Eco]	310 W
		[QUIET]	310 W
Standby mode power consumption	[Normal]	10 W	
	[Eco]	0.5 W	
BTU value		Max. 1,640 BTU	
DLP™ chip	Size		16.5 mm [0.65 in] diagonal (16:9 aspect ratio)
	Display system		1chip DLP™ projection system
	Number of pixels ²		2,073,600 (1920 x 1080 pixels)
Refresh rate		240 Hz Refresh rate varies depending on scanning frequency.	
Light source		Laser diode	
Light output ¹	Operation mode	[Normal]	5,200 lm / 5,400* lm (center) *Average light-output value of all shipped products measured at center of screen in [NORMAL] Mode.
		[Eco]	4,100 lm
		[QUIET]	4,100 lm
Time until light output declines to 50% ³	Operation mode	[Normal]	20,000 hours
		[Eco]	24,000 hours
		[QUIET]	20,000 hours
Resolution		3840 x 2160 pixels (with Quad Pixel Drive)	
Contrast ratio ¹		20,000:1 (All White/All Black) [PICTURE MODE] is set to [DYNAMIC], [OPERATING MODE] is set to [NORMAL], Dynamic Contrast [1].	
Screen size (diagonal)		40-300 in	
Center to corner zone ratio ¹		90%	
Lens		Manual zoom (throw ratio 1.46-2.93:1), Manual focus F 2.0-3.4, f 21.5-43.0 mm	
Lens shift (From the origin point of the lens mounter)		Vertical (Max) +71% -48%, Horizontal (Max) +34% -27%	
Installation		Ceiling/floor, front/rear, free 360-degree installation	
Compatible Signal	RGB signal input		Resolution: 640 x 480 to 1920 x 1200 Dot clock frequency: 162 MHz or less PIAS (Panasonic Intelligent Auto Scanning) system
	YCbCr/YPbPr signal input		Resolution: 480p/576p to 1920 x 1080 Dot clock frequency: 148.5 MHz or less The HD/SYNC and VD terminals do not support 3 value SYNC.
	HDMI signal input		Moving image signal resolution: 480p/576p to 4096 x 2160 Still image signal resolution: 640 x 480 to 1920 x 1200 (non-interlace) Dot clock frequency: 25 MHz to 594 MHz
	DIGITAL LINK signal input		Moving image signal resolution: 480p/576p to 4096 x 2160 Still image signal resolution: 640 x 480 to 1920 x 1200 (non-interlace) Dot clock frequency: 25 MHz to 297 MHz
Terminals	COMPUTER IN		D-sub HD 15-pin (female) x 1
	RGB signal	0.7 V [p-p] 75 Ω (SYNC ON GREEN: 1.0 V [p-p] 75 Ω) SYNC/HD TTL high impedance, automatic positive/negative polarity compatible VD TTL high impedance, automatic positive/negative polarity compatible	
		YPbPr signal	
	MONITOR OUT		D-sub HD 15-pin (female) x 1
	RGB signal	0.7 V [p-p] 75 Ω (SYNC ON GREEN: 1.0 V [p-p] 75 Ω) SYNC/HD TTL high impedance, automatic positive/negative polarity compatible VD TTL high impedance, automatic positive/negative polarity compatible	
		YPbPr signal	
	HDMI 1 IN/HDMI 2 IN		HDMI 19-pin x 2 Compatible with HDCP 2.3, Deep Color, 4K/60p signal input ⁴ , CEC supported
	Audio signal		Linear PCM (sampling frequency: 48 kHz/44.1 kHz/32 kHz)
	AUDIO IN		M3 stereo mini jack x 1 0.5 V [rms], input impedance 22 kΩ or more
	AUDIO OUT		M3 stereo mini jack x 1 0 V [rms] to 2.0 V [rms] (variable), output impedance 2.2 kΩ or lower
SERIAL IN		D-Sub 9 p x 1 RS-232C compliant, for computer control	
DIGITAL LINK/LAN		RJ-45 x 1 for network and DIGITAL LINK connections (HDBase™ compliant), PLink (class 2) compatible, 100Base-TX, Art-Net compatible, HDCP 2.3 compatible, Deep Color compatible, 4K/60p signal input ⁸	

Terminals	LAN	RJ-45 x 1 for network connection, PjLink (class 2) compatible, 10Base-T/100Base-TX, Art-Net compatible
	USB	USB connector (type A) x 1 for power supply (DC 5V, maximum 2A), for connecting USB memory and optional Wireless Module AJ-WM50
Power cord length		3.0 m [118-1/8 in], 2.0 m [78-3/4 in] (for Taiwan)
Cabinet materials		Molded plastic
Dimension (W x H x D)		498 x 168 ⁵ x 492 mm [19-5/8 x 6-5/8 ⁵ x 19-3/8 in]
Weight ⁶		Approx. 16.1 kg (35.8 lbs)
Operating noise ¹		35 dB [Normal][Eco] / 28 dB [QUIET]
Laser Classification	Laser Class	Class 1 (IEC/EN 60825-1:2014) China: Class 3R (IEC60825-1:2007)
	Risk Group	Risk Group 2 (IEC 62471-5:2015)
Operating environment	Operating temperature	0-45 °C (32-113 °F) ⁷
	Operating humidity	10-80% (no condensation)

Remote control unit

Power supply	3V DC (AAA/R03/LR03 battery x 2)
Operation range	Approx. 30 m [98 ft 5 in] (when operated directly in front of signal receiver)
Dimensions (W x H x D)	48 x 145 x 27 mm [1-7/8 x 5-23/32 x 1-1/16 in]
Weight	Approx. 102 g (3.60 ozs.) including batteries

Other Applications

- Multi Monitoring Control Software (for Windows)
- Logo Transfer Software (for Windows)
- Geometry Manager Pro (for Windows) *Feature only available after May 2022

Supplied accessories

- Wireless remote control unit (x 1)
- Power cord with secure lock (x 1) (x 2 for Europe/ASIA models)
- Batteries for remote control (AAA/R03 or AAA/LR03 battery x 2)

Optional accessories

- Ceiling Mount Bracket ET-PKD120H (for high ceiling)
ET-PKD120S (for low ceiling)
- Projector Mount Bracket ET-PKD130B
- DIGITAL LINK Switcher ET-YFB200G
- Digital Interface Box ET-YFB100G
- Early Warning Software ET-SWA100 Series *The suffix of the Model No. differs according to the license type.
- Wireless module AJ-WM50 Series *The suffix at the end of the model number is omitted. Operating temperature: 0-40°C (32-104 °F).
Product availability may vary by country or region.
- Geometry Manager Pro Upgrade kit (preactivated) ET-UK20 *Feature only available after May 2022
- Auto Screen Adjustment Upgrade kit (preactivated) ET-CUK10/CUK10P *Feature only available after May 2022

1 Measurement, measuring conditions, and method of notation all comply with ISO/IEC 21118: 2020 international standards
 2 When using a signal other than 120Hz/240hz, this resolution cannot be displayed.
 3 Around this time, light output will have decreased by approximately 50%. IEC62087: 2008 Broadcast contents, NORMAL Mode, Dynamic Contrast [2], under conditions with 30°C (86°F), 700m (2,297ft) above sea level, and 0.15 mg/m³ of particulate matter. Estimated time until light output declines to 50% varies depending on environment.
 4 4K/60p signals are converted to the projector's resolution upon projection. Supported terminals: DIGITAL LINK/HDMI®.
 5 With legs at shortest position.
 6 Average value. May differ depending on the actual unit.
 7 When using the projector at an altitude lower than 2700m (8858ft) above sea level, and the operating environment temperature becomes 29°C (84°F) or higher, the light output may be reduced to protect the projector.
 When using the projector at an altitude between 2700m (8858ft) and 4200m (13780ft), and the operating environment temperature becomes 25°C (77°F) or higher, the light output may be reduced to protect the projector.
 8 4K/60p signal input is converted to projector's resolution, supports YPbPr 4:2:0 format only.

Dimensions

unit : mm [inch]
NOTE: This illustration is not drawn to scale.

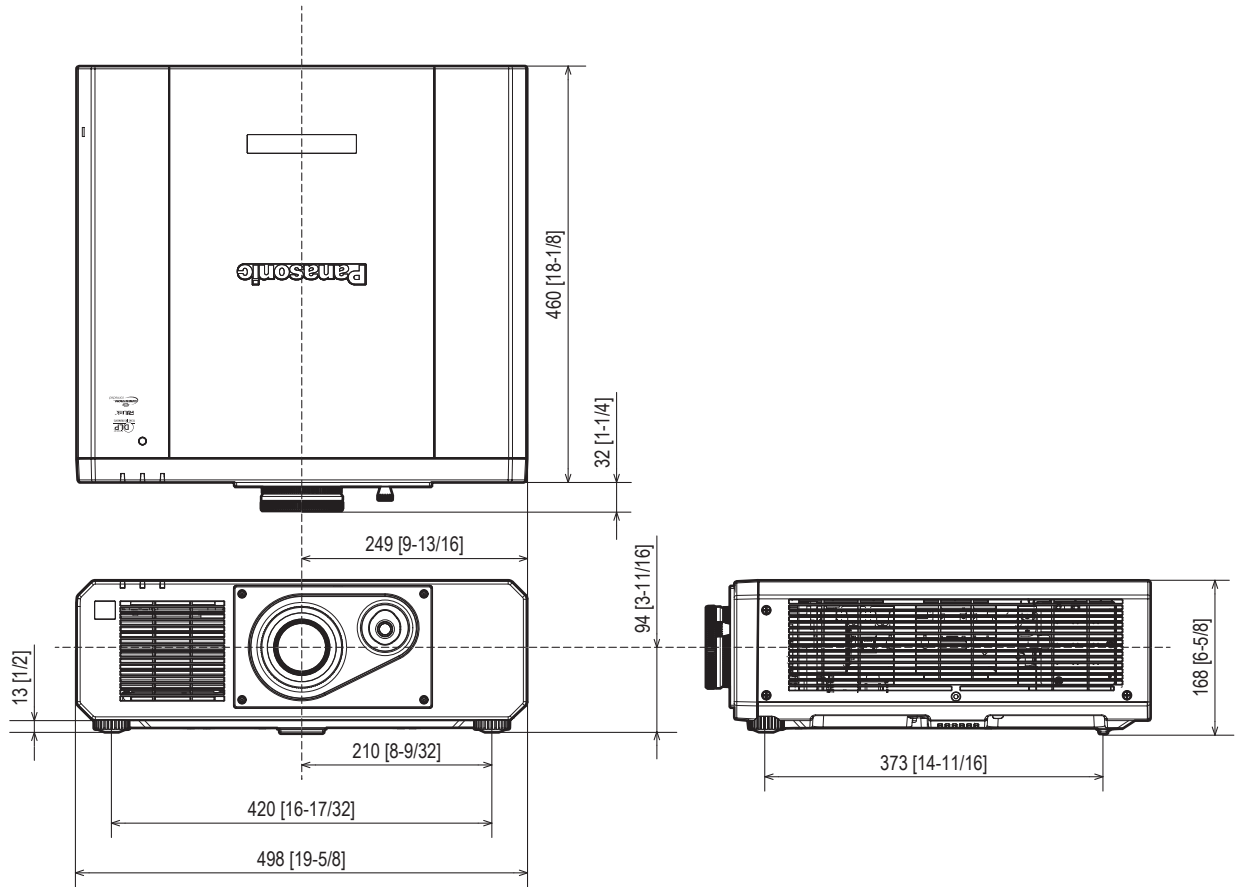

Terminals

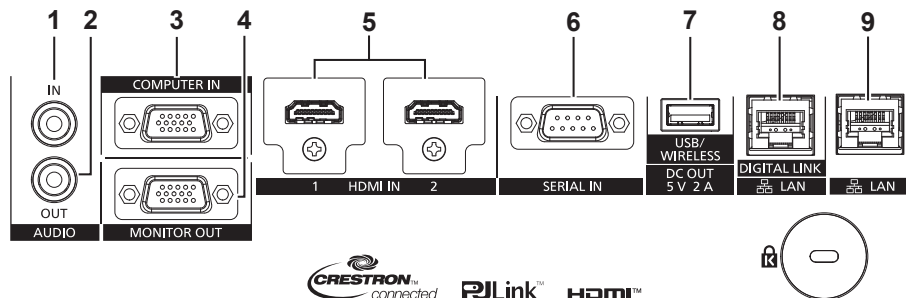

1	AUDIO IN	6	SERIAL IN
2	AUDIO OUT	7	USB (DC OUT)
3	COMPUTER IN	8	DIGITAL LINK/LAN
4	MONITOR OUT	9	LAN
5	HDMI 1 IN/HDMI 2 IN		

Projected image and throw distance

Install the projector referring to the projected image size and projection distance. Image size and image position can be adjusted in accordance with the screen size and screen position.

- Following illustration is prepared on the assumption that the projected image size and position have been aligned to fit full in the screen.

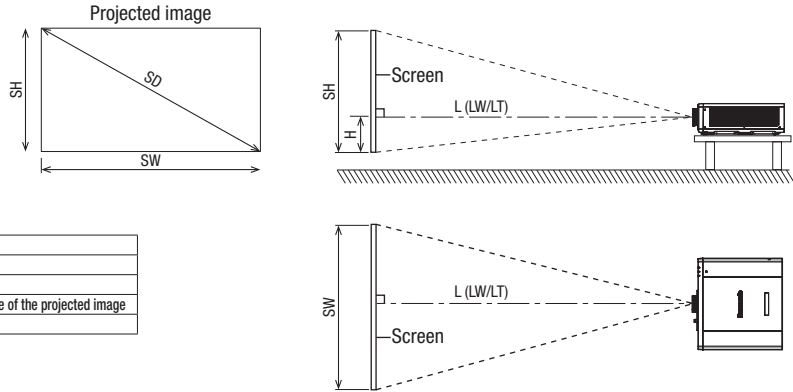

L (LW/LT) ¹	Projection distance
SH	Projected image height
SW	Projected image width
H	Distance from the lens center to the bottom edge of the projected image
SD	Projected image size

¹ LW : Minimum projection distance
 LT : Maximum projection distance

Standard setting-up position

Illustrations show the projector installed using optional ceiling mountbracket ET-PKD120H, optional bracket assembly ET-PKD130B.

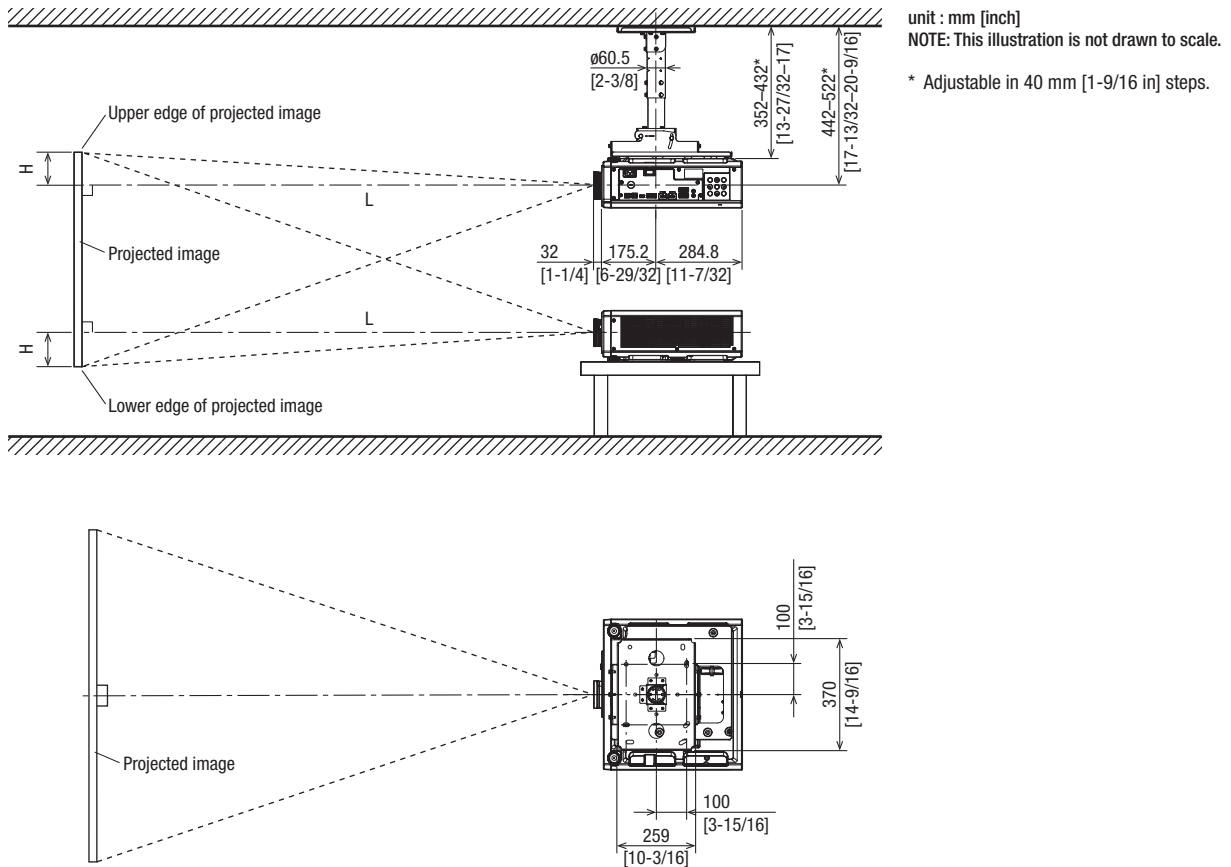

Caution

- All construction work should be done by a qualified technician.
- When mounting to the ceiling, use the special mounting bracket.
 Furthermore, in order to prevent it from falling down from the ceiling, use the supplied wire on the mounting bracket.

Standard setting-up position

Illustrations show the projector installed using optional ceiling mountbracket ET-PKD120S, optional bracket assembly ET-PKD130B.

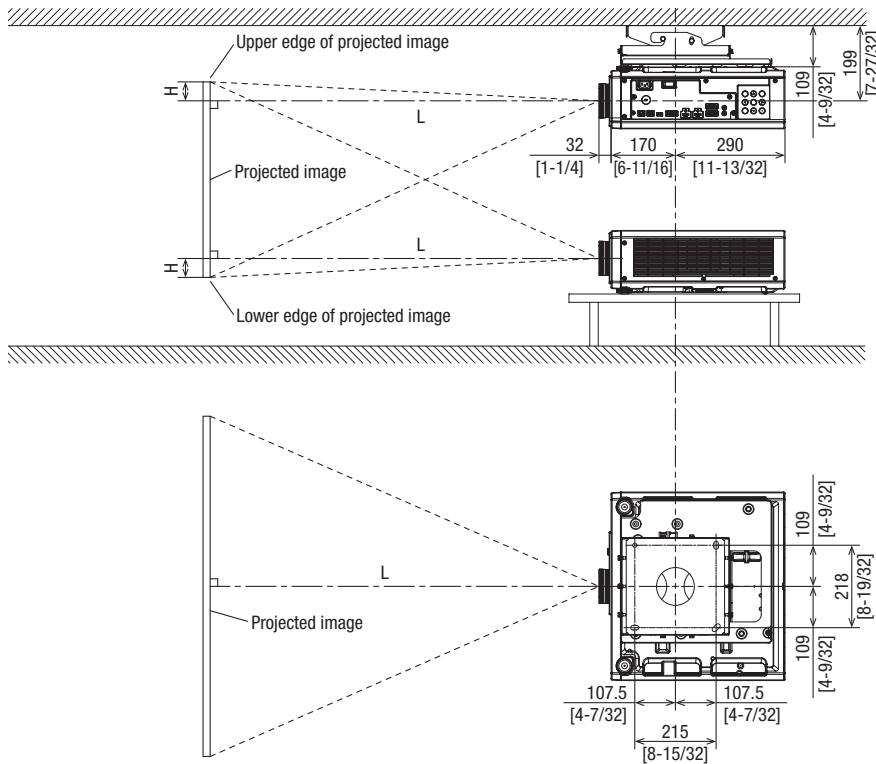

unit : mm [inch]
NOTE: This illustration is not drawn to scale.

Caution

- All construction work should be done by a qualified technician.
- When mounting to the ceiling, use the special mounting bracket.
Furthermore, in order to prevent it from falling down from the ceiling, use the supplied wire on the mounting bracket.

Projection distance

A ±5% error in listed projection distances may occur.

When [SCREEN ADJUSTMENT] is used, distance is corrected to become smaller than the specified image size.

Unit: meters

Projected image size	Aspect ratio 16:9			Aspect ratio 16:10			Aspect ratio 4:3		
	Projection distance (L)		Height position (H)	Projection distance (L)		Height position (H)	Projection distance (L)		Height position (H)
	Diagonal (SD)	Min. (LW)		Max. (LT)	Min. (LW)		Max. (LT)	Min. (LW)	
1.02/ 40	1.26	2.57	-0.10 - 0.49	1.36	2.78	-0.11 - 0.49	1.55	3.15	-0.13 - 0.60
1.27/ 50	1.59	3.22	-0.13 - 0.61	1.72	3.49	-0.14 - 0.61	1.95	3.95	-0.16 - 0.75
1.52/ 60	1.91	3.88	-0.16 - 0.73	2.07	4.19	-0.17 - 0.73	2.35	4.75	-0.19 - 0.90
1.78/ 70	2.24	4.53	-0.18 - 0.85	2.43	4.90	-0.20 - 0.85	2.75	5.55	-0.22 - 1.05
2.03/ 80	2.57	5.18	-0.21 - 0.98	2.78	5.60	-0.23 - 0.98	3.16	6.35	-0.26 - 1.19
2.29/ 90	2.90	5.83	-0.24 - 1.10	3.14	6.31	-0.25 - 1.10	3.56	7.15	-0.29 - 1.34
2.54/100	3.22	6.49	-0.26 - 1.22	3.49	7.02	-0.28 - 1.22	3.96	7.95	-0.32 - 1.49
3.05/120	3.88	7.79	-0.31 - 1.46	4.20	8.43	-0.34 - 1.46	4.76	9.54	-0.38 - 1.79
3.81/150	4.86	9.75	-0.39 - 1.83	5.26	10.54	-0.42 - 1.83	5.96	11.94	-0.48 - 2.24
5.08/200	6.50	13.01	-0.52 - 2.44	7.03	14.07	-0.57 - 2.44	7.97	15.93	-0.64 - 2.99
6.35/250	8.14	16.28	-0.65 - 3.05	8.81	17.60	-0.71 - 3.05	9.98	19.93	-0.80 - 3.73
7.62/300	9.78	19.54	-0.78 - 3.66	10.58	21.13	-0.85 - 3.66	11.98	23.92	-0.96 - 4.48

Unit: feet

Projected image size	Aspect ratio 16:9			Aspect ratio 16:10			Aspect ratio 4:3		
	Projection distance (L)		Height position (H)	Projection distance (L)		Height position (H)	Projection distance (L)		Height position (H)
	Diagonal (SD)	Min. (LW)		Max. (LT)	Min. (LW)		Max. (LT)	Min. (LW)	
1.02/ 40	4.13	8.43	-0.33 - 1.61	4.46	9.12	-0.36 - 1.61	5.09	10.33	-0.43 - 1.97
1.27/ 50	5.22	10.56	-0.43 - 2.00	5.64	11.45	-0.46 - 2.00	6.40	12.96	-0.52 - 2.46
1.52/ 60	6.27	12.73	-0.52 - 2.39	6.79	13.75	-0.56 - 2.39	7.71	15.58	-0.62 - 2.95
1.78/ 70	7.35	14.86	-0.59 - 2.79	7.97	16.08	-0.66 - 2.79	9.02	18.21	-0.72 - 3.44
2.03/ 80	8.43	16.99	-0.69 - 3.22	9.12	18.37	-0.75 - 3.22	10.37	20.83	-0.85 - 3.90
2.29/ 90	9.51	19.13	-0.79 - 3.61	10.30	20.70	-0.82 - 3.61	11.68	23.46	-0.95 - 4.40
2.54/100	10.56	21.29	-0.85 - 4.00	11.45	23.03	-0.92 - 4.00	12.99	26.08	-1.05 - 4.89
3.05/120	12.73	25.56	-1.02 - 4.79	13.78	27.66	-1.12 - 4.79	15.62	31.30	-1.25 - 5.87
3.81/150	15.94	31.99	-1.28 - 6.00	17.26	34.58	-1.38 - 6.00	19.55	39.17	-1.57 - 7.35
5.08/200	21.33	42.68	-1.71 - 8.01	23.06	46.16	-1.87 - 8.01	26.15	52.26	-2.10 - 9.81
6.35/250	26.71	53.41	-2.13 - 10.01	28.90	57.74	-2.33 - 10.01	32.74	65.39	-2.62 - 12.24
7.62/300	32.09	64.11	-2.56 - 12.01	34.71	69.32	-2.79 - 12.01	39.30	78.48	-3.15 - 14.70

Calculation of the projection distance

To use a projected image size not listed in this manual, check the projected image size SD (m) and use the respective formula to calculate the value.

The unit of all the formulae is m. (Values obtained by the following calculation formulae contain a slight error.)

When calculating the value using image size designation (value in inches), multiply the value in inches by 0.0254 and substitute it into SD in the formula.

	Aspect ratio 16:9	Aspect ratio 16:10	Aspect ratio 4:3
Projected image size Height (SH)	= SD x 0.490	= SD x 0.530	= SD x 0.6
Projected image size Width (SW)	= SD x 0.872	= SD x 0.848	= SD x 0.8
Minimum projection distance (LW)	= 1.2906 x SD - 0.0534	= 1.3952 x SD - 0.0534	= 1.5795 x SD - 0.0534
Maximum projection distance (LT)	= 2.5693 x SD - 0.0398	= 2.7776 x SD - 0.0398	= 3.1444 x SD - 0.0398

Adjustment range by the lens position shift (optical shift)

Based on the standard projection position using the optical axis shift function, the projection position can be adjusted in the range shown in the following figure.

Following figure shows the adjustment range when the projector is installed on the floor.

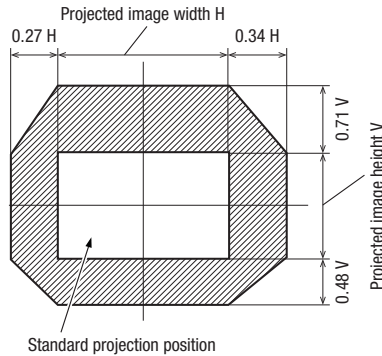

- Optimal image can be achieved by installing the projector squarely in front of the screen and adjusting the lens shift lever to center.

[SCREEN ADJUSTMENT] projection range

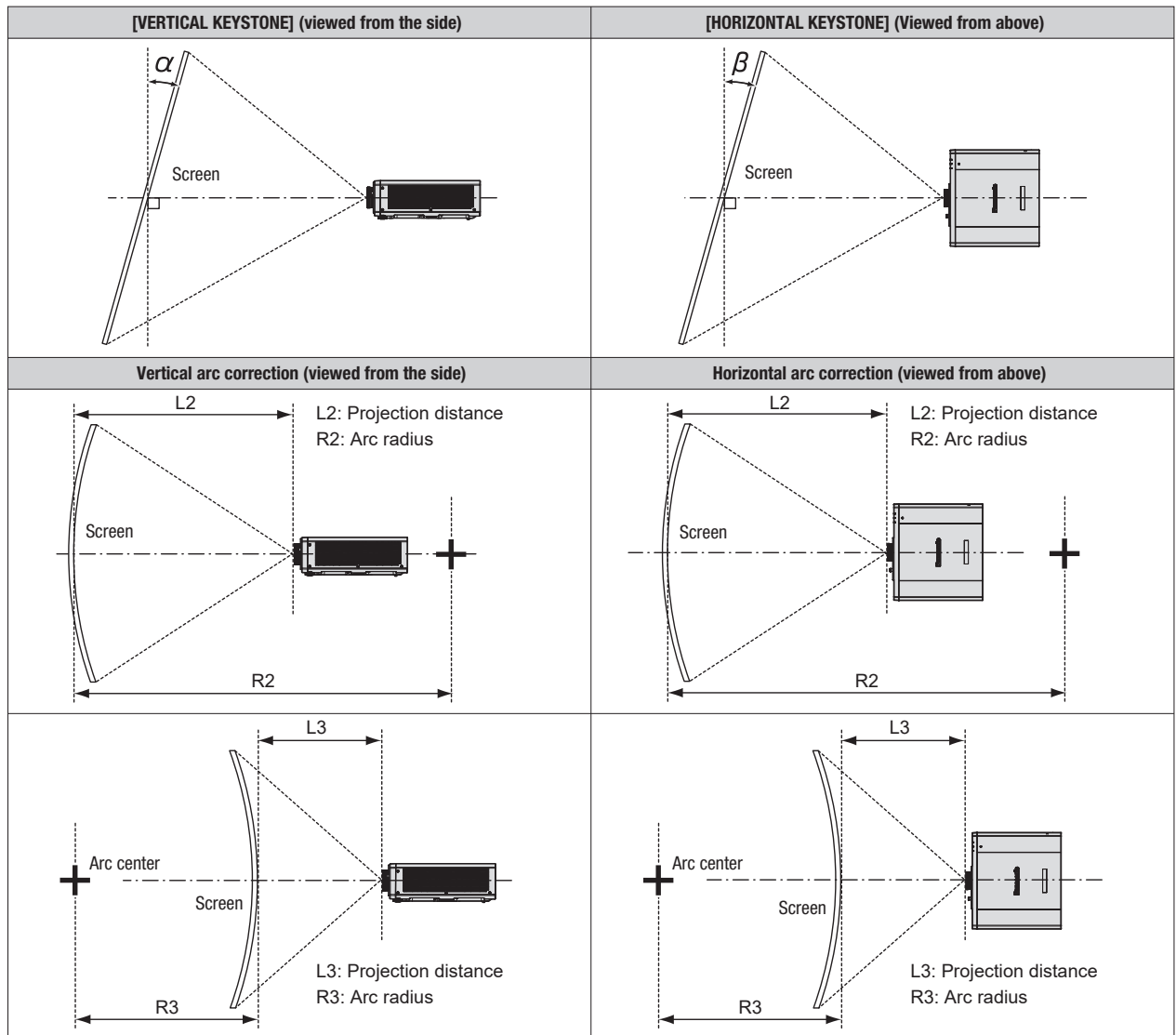

Only [KEystone] used		[KEystone] and [CURVED] used together				Only [CURVED] used	
Vertical keystone correction angle α (°)	Horizontal keystone correction angle β (°)	Vertical keystone correction angle α (°)	Horizontal keystone correction angle β (°)	Min. value of R2/L2	Min. value of R3/L3	Min. value of R2/L2	Min. value of R3/L3
±40	±20	±20	±15	0.9	1.8	0.5	1.0

- When [SCREEN ADJUSTMENT] is used, the focus of the entire screen may be lost as correction increases.
- Make the curved screen a circular arc shape with one part of a perfect circle removed.

Installable angle

Install the projector at an angle within the range shown below.

Projection in all 360° direction

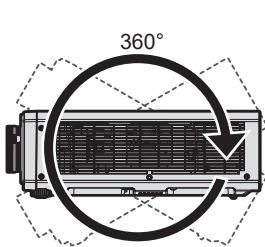

360° vertically

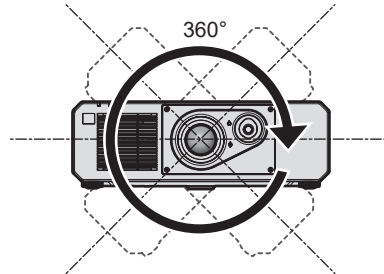

360° horizontally

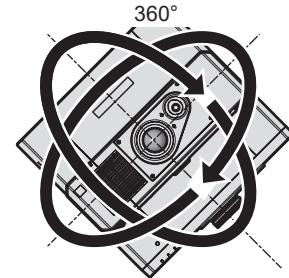

360° tilted
(combination of vertical and horizontal)

Cautions when setting up the projector

- Do not stack projectors on top of each other.
- Do not use the projector supporting it by the top.
- Do not block the intake and exhaust vents of the projector.
- Prevent hot and cool air from the air conditioning system to blow directly to the intake and exhaust vents of the projector.

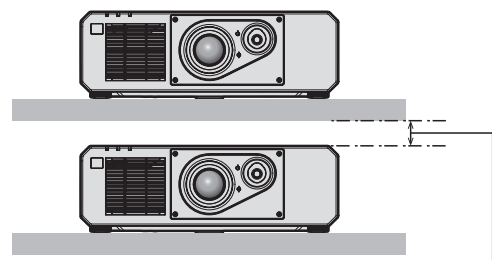
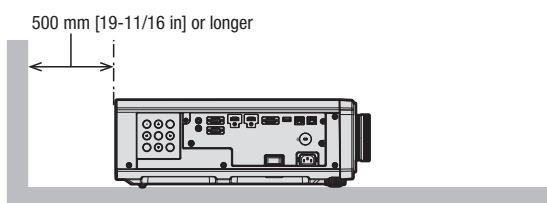
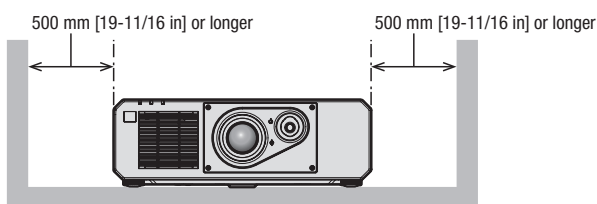
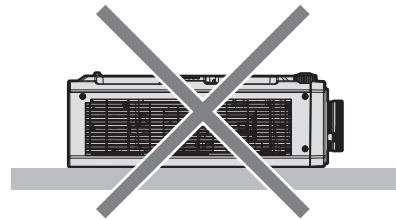
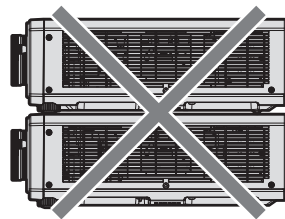

100 mm [3-15/16 in] or longer

- Do not install the projector in a confined space.
When installing the projector in a confined space, provide air conditioning or ventilation separately. Exhaust heat may accumulate when the ventilation is not enough, triggering the protection circuit of the projector.

List of compatible signals

The following table specifies the image signals that the projector can project. This projector supports the signal with ✓ in the compatible signal column.

• The content of the signal type column is as follows.

–V: Video signal –C: Computer signal

Signal type	Signal name (SIGNAL FORMAT)	Resolution (Dots)	Scanning freq.		Dot clock freq. (MHz)	Compatible signal		
			Horizontal (kHz)	Vertical (Hz)		COMPUTER	HDMI	DIGITAL LINK
V	480/60p	720 x 480	31.5	59.9	27.0	✓	✓	✓
	576/50p	720 x 576	31.3	50.0	27.0	✓	✓	✓
	720/60p	1280 x 720	45.0	60.0 ¹	74.3	✓	✓	✓
	720/50p	1280 x 720	37.5	50.0	74.3	✓	✓	✓
	1080/60i	1920 x 1080i	33.8	60.0 ¹	74.3	✓	✓	✓
	1080/50i	1920 x 1080i	28.1	50.0	74.3	✓	✓	✓
	1080/24p	1920 x 1080	27.0	24.0 ¹	74.3	✓	✓	✓
	1080/24sF	1920 x 1080i	27.0	48.0 ¹	74.3	✓	✓	✓
	1080/25p	1920 x 1080	28.1	25.0	74.3	✓	✓	✓
	1080/30p	1920 x 1080	33.8	30.0 ¹	74.3	✓	✓	✓
	1080/60p	1920 x 1080	67.5	60.0 ¹	148.5	✓	✓	✓
	1080/50p	1920 x 1080	56.3	50.0	148.5	✓	✓	✓
	1080/120p	1920 x 1080	135.0	120.0 ¹	297.0	–	✓	✓
	3840 x 2160/24p	3840 x 2160	54.0	24.0 ¹	297.0	–	✓	✓
	3840 x 2160/25p	3840 x 2160	56.3	25.0	297.0	–	✓	✓
	3840 x 2160/30p	3840 x 2160	67.5	30.0 ¹	297.0	–	✓	✓
	3840 x 2160/60p	3840 x 2160	135.0	60.0 ¹	297.0	–	✓ ²	✓ ²
		3840 x 2160	135.0	60.0 ¹	594.0	–	✓	–
	3840 x 2160/50p	3840 x 2160	112.5	50.0	297.0	–	✓ ²	✓ ²
		3840 x 2160	112.5	50.0	594.0	–	✓	–
	4096 x 2160/24p	4096 x 2160	54.0	24.0 ¹	297.0	–	✓	✓
	4096 x 2160/25p	4096 x 2160	56.3	25.0	297.0	–	✓	✓
	4096 x 2160/30p	4096 x 2160	67.5	30.0 ¹	297.0	–	✓	✓
	4096 x 2160/60p	4096 x 2160	135.0	60.0 ¹	297.0	–	✓ ²	✓ ²
		4096 x 2160	135.0	60.0 ¹	594.0	–	✓	–
	4096 x 2160/50p	4096 x 2160	112.5	50.0	297.0	–	✓ ²	✓ ²
4096 x 2160		112.5	50.0	594.0	–	✓	–	
C	640 x 480/60	640 x 480	31.5	59.9	25.2	✓	✓	✓
	1024 x 768/50	1024 x 768	39.6	50.0	51.9	✓	✓	✓
	1024 x 768/60	1024 x 768	48.4	60.0	65.0	✓	✓	✓
	1280 x 800/50	1280 x 800	41.3	50.0	68.0	✓	✓	✓
	1280 x 800/60	1280 x 800	49.7	59.8	83.5	✓	✓	✓
	1280 x 1024/50	1280 x 1024	52.4	50.0	88.0	✓	✓	✓
	1280 x 1024/60	1280 x 1024	64.0	60.0	108.0	✓	✓	✓
	1366 x 768/50	1366 x 768	39.6	49.9	69.0	✓	✓	✓
	1366 x 768/60	1366 x 768	47.7	59.8	85.5	✓	✓	✓
	1400 x 1050/50	1400 x 1050	54.1	50.0	99.9	✓	✓	✓
	1400 x 1050/60	1400 x 1050	65.2	60.0	122.6	✓	✓	✓
	1440 x 900/50	1440 x 900	46.3	49.9	86.8	✓	✓	✓
	1440 x 900/60	1440 x 900	55.9	59.9	106.5	✓	✓	✓
	1600 x 900/50	1600 x 900	46.4	49.9	96.5	✓	✓	✓
	1600 x 900/60	1600 x 900	55.9	60.0	119.0	✓	✓	✓
	1600 x 1200/50	1600 x 1200	61.8	49.9	131.5	✓	✓	✓
	1600 x 1200/60	1600 x 1200	75.0	60.0	162.0	✓	✓	✓
	1680 x 1050/50	1680 x 1050	54.1	50.0	119.5	✓	✓	✓
	1680 x 1050/60	1680 x 1050	65.3	60.0	146.3	✓	✓	✓
	1920 x 1080/240	1920 x 1080	291.6	240.0	583.2	–	✓	–
	1920 x 1200/50	1920 x 1200	61.8	49.9	158.3	✓	✓	✓
	1920 x 1200/60RB	1920 x 1200 ³	74.0	60.0	154.0	✓	✓	✓
	2560 x 1600/50	2560 x 1600	82.4	50.0	286.0	–	✓	✓
	2560 x 1600/60	2560 x 1600 ³	98.7	60.0	268.5	–	✓	✓

1 The signal with 1/1.001x vertical scanning frequency is also supported. 2 YpPr 4:2:0 format only 3 VESA CVT-RB (Reduced Blanking)-compliant

Note

- A signal with a different resolution is converted to the number of display dots. The number of display dots is as follows. 3840 x 2160
However, when the input signal is 1080/120p or 1920 x 1080/240, the number of display dots is as follows. 1920 x 1080
- The "i" at the end of the resolution indicates an interlaced signal.
- When interlaced signals are connected, flickering may occur on the projected image.
- When the DIGITAL LINK connection is made with the long-reach communication method, the signal that the projector can receive is up to 1080/60p (1920 x 1080 dots, dot clock frequency 148.5 MHz).
- Even if it is the signal listed in the list of compatible signals, it may not be displayed by the projector if the image signal is recorded in a special format.

List of Plug and play compatible signals

The following table specifies the image signals compatible with plug and play.

Signal with ✓ in the plug and play compatible signal column is the signal described in the EDID (extended display identification data) of the projector. For the signal without ✓ in the plug and play compatible signal column, the resolution may not be selected on the computer even if the projector is supporting it.

Signal name (SIGNAL FORMAT)	Resolution (Dots)	Scanning freq.		Dot clock freq. (MHz)	Plug and play compatible signal						
		Horizontal (kHz)	Vertical (Hz)		COMPUTER	HDMI			DIGITAL LINK		
						4K/60p/HDR 4K/60p/SDR	4K/30p	2K	4K/60p	4K/30p/HDR 4K/30p/SDR	2K
480/60p	720 x 480	31.5	59.9	27.0	-	✓	✓	✓	✓	✓	✓
576/50p	720 x 576	31.3	50.0	27.0	-	✓	✓	✓	✓	✓	✓
720/60p	1280 x 720	45.0	60.0	74.3	-	✓	✓	✓	✓	✓	✓
720/50p	1280 x 720	37.5	50.0	74.3	-	✓	✓	✓	✓	✓	✓
1080/60i	1920 x 1080i	33.8	60.0	74.3	-	✓	✓	✓	✓	✓	✓
1080/50i	1920 x 1080i	28.1	50.0	74.3	-	✓	✓	✓	✓	✓	✓
1080/24p	1920 x 1080	27.0	24.0	74.3	-	✓	✓	✓	✓	✓	✓
1080/24sF	1920 x 1080i	27.0	48.0	74.3	-	-	-	-	-	-	-
1080/25p	1920 x 1080	28.1	25.0	74.3	-	✓	✓	✓	✓	✓	✓
1080/30p	1920 x 1080	33.8	30.0	74.3	-	✓	✓	✓	✓	✓	✓
1080/60p	1920 x 1080	67.5	60.0	148.5	-	✓	✓	✓	✓	✓	✓
1080/50p	1920 x 1080	56.3	50.0	148.5	-	✓	✓	✓	✓	✓	✓
1080/120p	1920 x 1080	135.0	120.0	297.0	-	✓	✓	-	✓	✓	-
3840 x 2160/24p	3840 x 2160	54.0	24.0	297.0	-	✓	✓	-	✓	✓	-
3840 x 2160/25p	3840 x 2160	56.3	25.0	297.0	-	✓	✓	-	✓	✓	-
3840 x 2160/30p	3840 x 2160	67.5	30.0	297.0	-	✓	✓	-	✓	✓	-
3840 x 2160/60p	3840 x 2160	135.0	60.0	297.0	-	✓ ¹	-	-	✓ ¹	-	-
	3840 x 2160	135.0	60.0	594.0	-	✓	-	-	-	-	-
3840 x 2160/50p	3840 x 2160	112.5	50.0	297.0	-	✓ ¹	-	-	✓ ¹	-	-
	3840 x 2160	112.5	50.0	594.0	-	✓	-	-	-	-	-
4096 x 2160/24p	4096 x 2160	54.0	24.0	297.0	-	✓	✓	-	✓	✓	-
4096 x 2160/25p	4096 x 2160	56.3	25.0	297.0	-	✓	✓	-	✓	✓	-
4096 x 2160/30p	4096 x 2160	67.5	30.0	297.0	-	✓	✓	-	✓	✓	-
4096 x 2160/60p	4096 x 2160	135.0	60.0	297.0	-	✓ ¹	-	-	✓ ¹	-	-
	4096 x 2160	135.0	60.0	594.0	-	✓	-	-	-	-	-
4096 x 2160/50p	4096 x 2160	112.5	50.0	297.0	-	✓ ¹	-	-	✓ ¹	-	-
	4096 x 2160	112.5	50.0	594.0	-	✓	-	-	-	-	-
640 x 480/60	640 x 480	31.5	59.9	25.2	✓	✓	✓	✓	✓	✓	✓
1024 x 768/50	1024 x 768	39.6	50.0	51.9	-	-	-	-	-	-	-
1024 x 768/60	1024 x 768	48.4	60.0	65.0	✓	✓	✓	✓	✓	✓	✓
1280 x 800/50	1280 x 800	41.3	50.0	68.0	-	-	-	-	-	-	-
1280 x 800/60	1280 x 800	49.7	59.8	83.5	-	-	-	-	-	-	-
1280 x 1024/50	1280 x 1024	52.4	50.0	88.0	-	-	-	-	-	-	-
1280 x 1024/60	1280 x 1024	64.0	60.0	108.0	-	-	-	-	-	-	-
1366 x 768/50	1366 x 768	39.6	49.9	69.0	-	-	-	-	-	-	-
1366 x 768/60	1366 x 768	47.7	59.8	85.5	-	-	-	-	-	-	-
1400 x 1050/50	1400 x 1050	54.1	50.0	99.9	-	-	-	-	-	-	-
1400 x 1050/60	1400 x 1050	65.2	60.0	122.6	✓	✓	✓	✓	✓	✓	✓
1440 x 900/50	1440 x 900	46.3	49.9	86.8	-	-	-	-	-	-	-
1440 x 900/60	1440 x 900	55.9	59.9	106.5	-	-	-	-	-	-	-
1600 x 900/50	1600 x 900	46.4	49.9	96.5	-	-	-	-	-	-	-
1600 x 900/60	1600 x 900	55.9	60.0	119.0	✓	✓	✓	✓	✓	✓	✓
1600 x 1200/50	1600 x 1200	61.8	49.9	131.5	-	-	-	-	-	-	-
1600 x 1200/60	1600 x 1200	75.0	60.0	162.0	✓	✓	✓	✓	✓	✓	✓
1680 x 1050/50	1680 x 1050	54.1	50.0	119.5	-	-	-	-	-	-	-
1680 x 1050/60	1680 x 1050	65.3	60.0	146.3	-	-	-	-	-	-	-
1920 x 1080/240	1920 x 1080	291.6	240.0	583.2	-	✓	-	-	-	-	-
1920 x 1200/50	1920 x 1200	61.8	49.9	158.3	-	-	-	-	-	-	-
1920 x 1200/60RB	1920 x 1200 ²	74.0	60.0	154.0	✓	✓	✓	✓	✓	✓	✓
2560 x 1600/50	2560 x 1600	82.4	50.0	286.0	-	-	-	-	-	-	-
2560 x 1600/60	2560 x 1600 ²	98.7	60.0	268.5	-	-	-	-	-	-	-

1 YPbPr 4:2:0 format only
 2 VESA CVT-RB (Reduced Blanking)-compliant

Note

- The “i” at the end of the resolution indicates an interlaced signal.
- When interlaced signals are connected, flickering may occur on the projected image.