

Unite Cockpit Case (CC) Charger

CONFERENCE



Unite CC-28/2



Unite CC-36/2

Description

The Unite Cockpit Case is a multifunctional device. It charges the integrated batteries in Unite mobile transmitters and receivers, and stores and relays pairing information (channel name, group ID, audio key).

For maximum protection against unauthorised listening, a group-ID-dependent audio code is generated in the charger and relayed to the mobile devices during the pairing process. The charger can be integrated into a network via the Ethernet port, and combined with other Unite Cockpit chargers and Unite AP4 Access Points. The Unite Manager PC software enables further functionality within the network: monitoring, maintenance, advanced configuration, pairing and set-up of transmitters, receivers and Unite AP4 Access Points.

Features

Intelligent transport, charging and storage case including pairing and network functions.

- » Controls:
 - Buttons and status light for the pairing process
 - Switch for "Pairing & charging" or "Charging"
 - Reset button
- » Ethernet port for network integration
- » USB connector:
 - Pairing
 - Charging
- » Additional options via Unite Manager PC software:
 - Advanced configuration
 - Pairing via several chargers
 - Customisable AES-256 encryption
 - Storing of pairing information
 - Monitoring
 - Maintenance
 - Device software updates
- » Detachable, lockable lid
- » Ergonomic carrying handle
- » Sturdy wood construction
- » Laminated housing
- » Reinforced aluminium frame
- » Stackable housing corners
- » Sideward adjustable feet
- » Integrated power adapter with switchable, fused IEC mains connection
- » Active ventilator

Specifications

AC input	100-240 V AC, 50-60 Hz
Fuse	2 x 3.15 A (slow-blow)
Nominal current	2.2 A @115 V AC 1.1 A @230 V
Power consumption	150 W for 24 charging slots 225 W for 36 charging slots
Max. charging time	Approx. 4 hours
Connections	Ethernet USB, type C Power plug with switch
Ambient temperature	0 - 30°C optimum operation (the listed charging times were obtained within this range)
	Charging time longer at 30°C (sustained operation is not recommended)
	Operation is not possible at 40°C and above
	Storage: -20 to +50°C
Relative humidity	0 - 90%
Dimensions inc. handle and feet (L x W x H)	54 x 45 x 19 cm
Weight	
Unite CC-28/2	<ul style="list-style-type: none"> • 12.7 kg (empty) • ± 15.5 kg (full)
Unite CC-36/2	<ul style="list-style-type: none"> • 13.0 kg (empty) • ± 16.8 kg (full)

Accessories Included in Deliver

- » Power cable
- » Lid key

Versions

Incl. USB, network connection and integrated power adapter

Versions	Charging slots for pocket devices	Combination charging slots for handheld transmitters or pocket devices*	Ref.
Unite CC-28/2	28	2	71.98.4040
Unite CC-36/2	36	2	71.98.4041

* The number of charging slots for pocket devices is reduced when charging handheld transmitters.

Dimensions in mm and [inches]

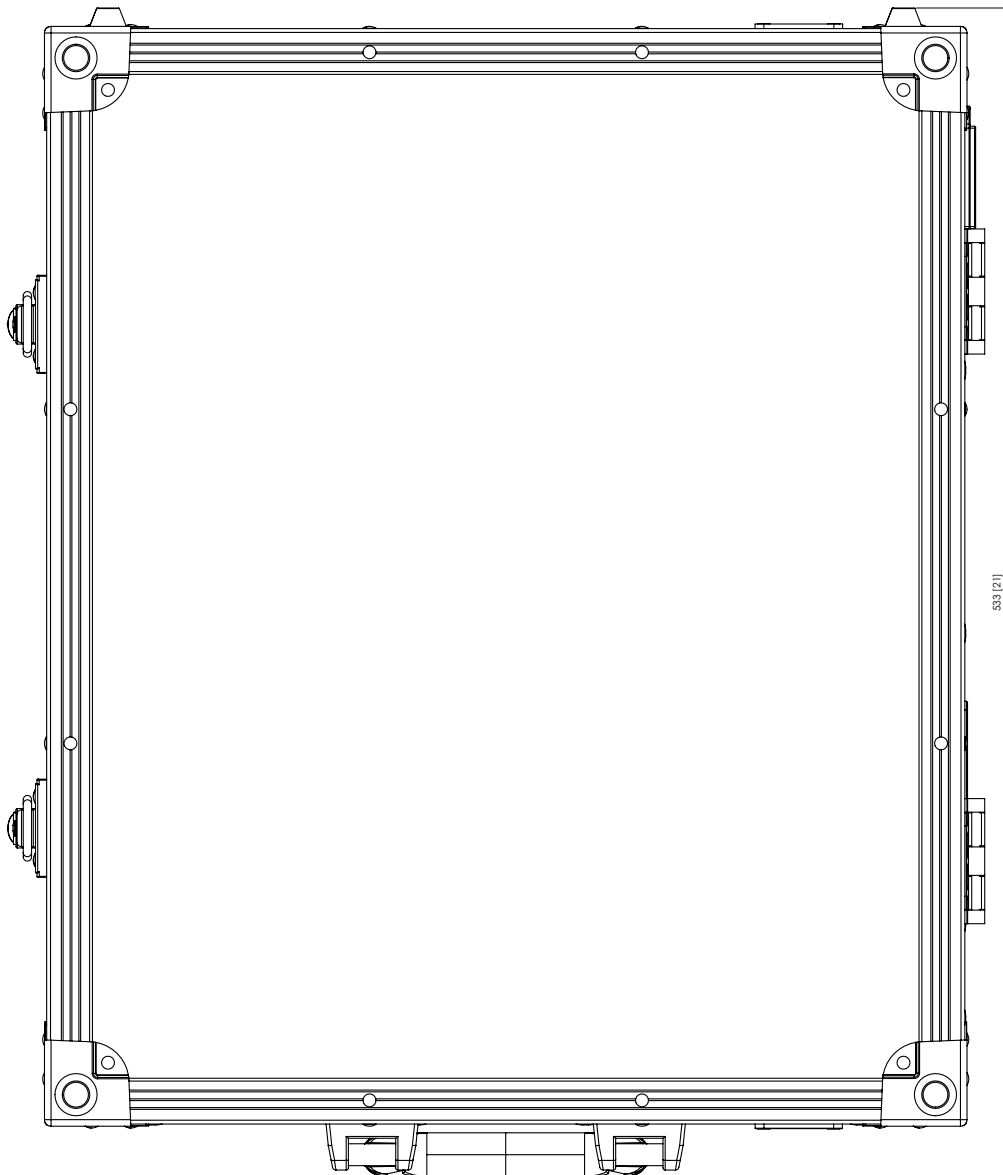
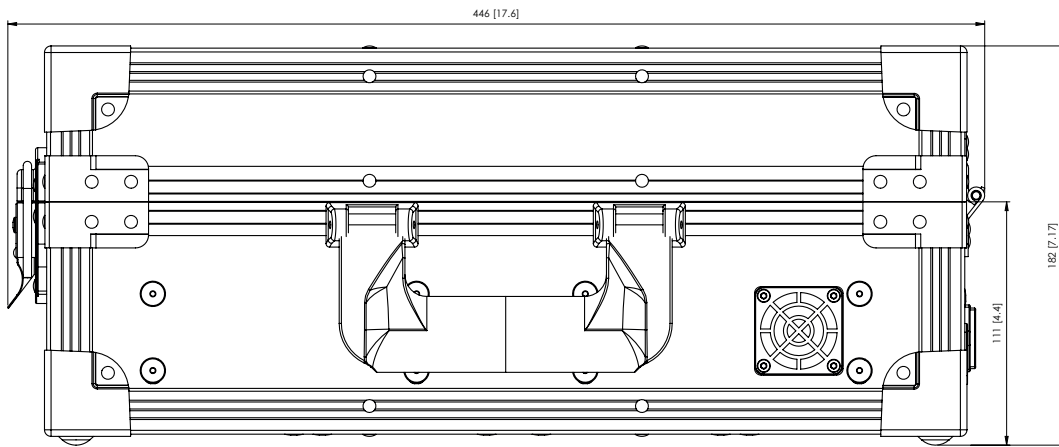

HQ Belgium

+32 51 30 30 45

conference@televic.com

<https://www.televic.com/en/conference>

Asia

+86 21 61 48 01 23

conference@televic.com

www.televic-conference.com.cn

France

+33 3 74 09 52 76

conference-france@televic.com

www.televic-conference.fr

United States

+1 916 920 0901

conference-us@televic.com

All information copyright Televic Conference, 2023.

Televic reserves the right to change this document without notice.

Version 1.0

