

2425

é[®] SISTEMAS
VISUAL COMMUNICATION SOLUTIONS
MULTIMEDIA PRODUCTS

EDUCATION SOLUTIONS

esistemas.pt

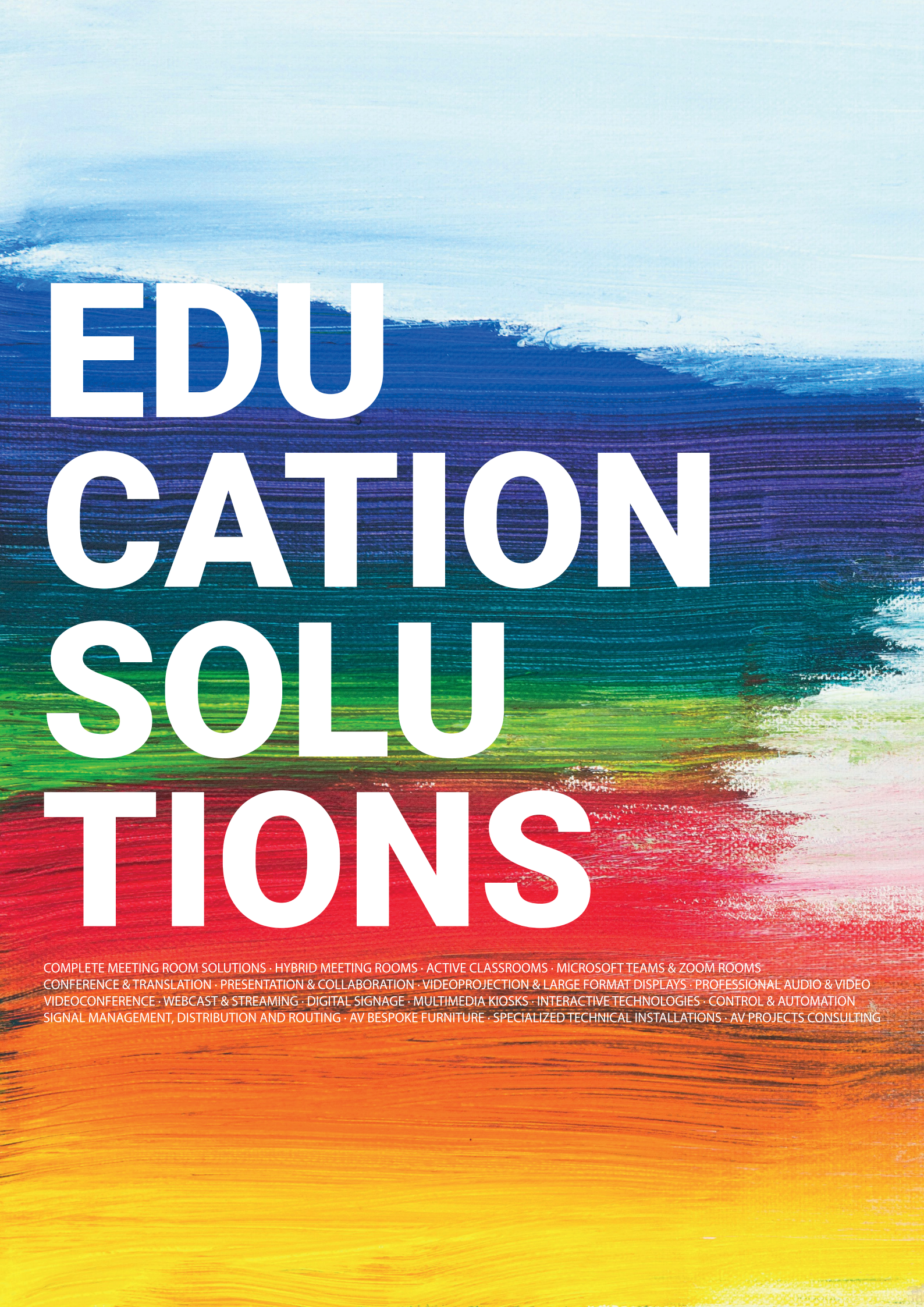

EDU CATION SOLU TIONS

COMPLETE MEETING ROOM SOLUTIONS · HYBRID MEETING ROOMS · ACTIVE CLASSROOMS · MICROSOFT TEAMS & ZOOM ROOMS
CONFERENCE & TRANSLATION · PRESENTATION & COLLABORATION · VIDEOPROJECTION & LARGE FORMAT DISPLAYS · PROFESSIONAL AUDIO & VIDEO
VIDEOCONFERENCE · WEBCAST & STREAMING · DIGITAL SIGNAGE · MULTIMEDIA KIOSKS · INTERACTIVE TECHNOLOGIES · CONTROL & AUTOMATION
SIGNAL MANAGEMENT, DISTRIBUTION AND ROUTING · AV BESPOKE FURNITURE · SPECIALIZED TECHNICAL INSTALLATIONS · AV PROJECTS CONSULTING

ÍNDICE

.00	INTRODUÇÃO.....	04
.01	VÍDEOPROJEÇÃO.....	08
.02	ECRANS DE PROJEÇÃO.....	12
.03	SOLUÇÕES INTERATIVAS.....	14
.04	DISPLAYS PROFISSIONAIS.....	16
.05	QUIOSQUES / DIGITAL SIGNAGE.....	18
.06	SOLUÇÕES COLABORATIVAS.....	20
.07	SISTEMAS DE CONFERÊNCIA.....	32
.08	CONTROLO E INTEGRAÇÃO.....	34
.09	GESTÃO DE SINAL.....	36
.10	VÍDEO PROFISSIONAL.....	38
.11	ÁUDIO E COMPLEMENTOS AV.....	42
.12	SOLUÇÕES EM SUPORTES.....	46
.13	MOBILIÁRIO / MATERIAL DIDÁTICO.....	51
.14	CONTRATOS DE MANUTENÇÃO.....	54

EDUCAÇÃO PARA TODOS E EM QUALQUER LUGAR

A era do
Blended Learning

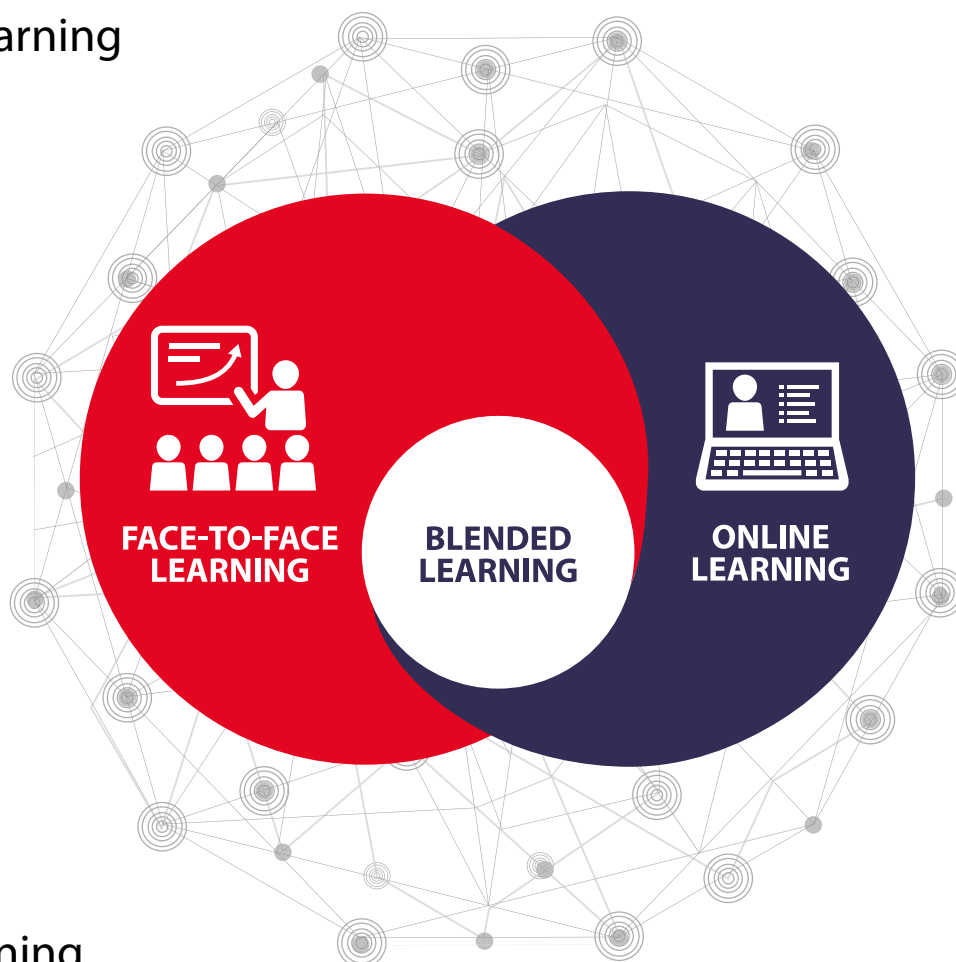

Hybrid Learning

- Partilha de conteúdos

- Colaboração on-time entre professores e alunos

- Aprendizagem baseada em jogos didáticos

- Avaliações formativas

• E ainda diversos elementos que permitem aos alunos, onde quer que estejam, estabelecerem uma interação com o conteúdo apresentado pelos professores



SALAS TIPO | EXEMPLOS REAIS

SALA TIPO 1

- DISPLAY INTERATIVO SMART®
- HUB AV PROFESSIONAL USB
- CÂMARA PTZ LONG ZOOM
- MICROFONE DE TETO / MESA

SALA TIPO 1

SALA TIPO 2

- DISPLAY INTERATIVO SMART®
- CÂMARA PTZ LONG ZOOM
- MICROFONE DE TETO / MESA

SALA TIPO 2



The diagram illustrates the 'SALA TIPO 3' setup. A central 'DISPLAY INTERATIVO SMART' is mounted on a wall. A teacher stands in front of it, pointing at a diagram of geometric shapes and the equation $E = MC^2$. A 'CÂMARA DE VIDEOCONFERÊNCIA' is mounted above the display, and a 'MICROFONE DE TETO / MESA' is positioned nearby. A 'MATRIZ UC' (matrix switch) is connected to the display and a laptop on a desk. The laptop is connected to a desktop PC tower. A 'LIGAÇÃO WIFI ALTA VELOCIDADE' is shown connecting the system to a cloud of 'ALUNOS EM CASA REMOTAMENTE' (remote students). Below the main setup, two students are seated at desks with laptops, connected to the system via 'PARTILHA DE CONTEÚDOS WIRELESS' (wireless content sharing).

SALA TIPO 3

- DISPLAY INTERATIVO SMART®
- MATRIZ UC (HDMI/USB-C)
- CÂMARA PTZ LONG ZOOM
- MICROFONE DE TETO / MESA
- CAIXA DE CONTROLO

SALA TIPO 3



The diagram illustrates the 'SALA PORTÁTIL' setup. A 'DISPLAY INTERATIVO SMART' is mounted on a 'CARRINHO COM RODAS' (wheeled cart). A teacher stands next to it, pointing at the same diagram and equation as in the previous setup. A 'CÂMARA DE VIDEOCONFERÊNCIA' is mounted on top of the cart. A laptop on a desk is connected to the display via 'USB-A/B' and 'HDMI'. A 'LIGAÇÃO WIFI ALTA VELOCIDADE' is shown connecting the system to a cloud of 'ALUNOS EM CASA REMOTAMENTE'. Below the main setup, two students are seated at desks with laptops, connected to the system via 'PARTILHA DE CONTEÚDOS WIRELESS'.

SALA PORTÁTIL

- DISPLAY INTERATIVO SMART®
- CÂMARA VÍDEOCONFERÊNCIA (VÁRIAS OPÇÕES DISPONÍVEIS)
- CARRINHO COM RODAS

SALA PORTÁTIL

ESTÃO DISPONÍVEIS MAIS CONFIGURAÇÕES DE SALAS DE FORMA A DAR RESPOSTA ÀS NECESSIDADES DE CADA CLIENTE.



CTE

CENTROS TECNOLÓGICOS ESPECIALIZADOS

MODERNIZAÇÃO DOS ESTABELECIMENTOS | JUNTOS MODERNIZAMOS O FUTURO



CONSULTE-NOS PARA
MAIS INFORMAÇÕES

XGA, WXGA, FULL HD, WUXGA, 4K UHD



PICTURE BY
DLP
TEXAS INSTRUMENTS



Info

VÁRIOS MODELOS E
OPÇÕES DISPONÍVEIS
CONSULTE-NOS PARA
MAIS INFORMAÇÕES



GAMA MOBILE / LED
RESOLUÇÕES ATÉ WUXGA
ATÉ 5000 ANSI LUMENS
AMPLA CONECTIVIDADE



GAMA DESKTOP · INSTALL
RESOLUÇÕES ATÉ UHD
ATÉ 10.000 ANSI LUMENS
AMPLA CONECTIVIDADE



LASER



WIRELESS
ACESSÓRIOS

QuickCast
HDCast Pro
Wireless USB Adapter
Wireless HDMI System
WHD200



**VISUALIZADOR
DE DOCUMENTOS**
RESOLUÇÕES ATÉ 4K



Optoma

SHORT THROW ULTRA SHORT THROW

series

59%
SOLAR RADIATION

845,000
METRIC
UNIVERSITY

47%
GLACIERS

VÍDEOPROJEÇÃO **.01**



+
GAMA CURTA / ULTRA CURTA DISTÂNCIA
RESOLUÇÕES ATÉ UHD
ATÉ 5000 ANSI LUMENS
AMPLA CONECTIVIDADE

FULL HD, WUXGA, 4K UHD



—
PICTURE BY
DLP
TEXAS INSTRUMENTS
LCD
—



GAMA PROFISSIONAL
PE Series | P Series | PV Series
RESOLUÇÕES ATÉ WUXGA
ATÉ 8000 ANSI LUMENS
AMPLA CONECTIVIDADE



GAMA INSTALAÇÃO
PA Series | PX Series | PH Series
RESOLUÇÕES ATÉ UHD
ATÉ 35.000 ANSI LUMENS
AMPLA CONECTIVIDADE



3
ANOS
GARANTIA

(ON SITE)
VÁLIDO PARA
TODOS OS MODELOS



VÁRIOS MODELOS E
OPÇÕES DISPONÍVEIS
CONSULTE-NOS PARA
MAIS INFORMAÇÕES



SUPER SILENT
PROJECTION

LASER
PHOSPHOR

XGA, WXGA, FULL HD, WUXGA, 4K UHD

LCD

1-CHIP DLP™

3-CHIP DLP™

MAKE YOUR AUDIENCE GO WILD



Info

VÁRIOS MODELOS E
OPÇÕES DISPONÍVEIS
CONSULTE-NOS PARA
MAIS INFORMAÇÕES

02. ECRANS DE PROJEÇÃO

ecrans de projeção

as melhores soluções
para a sua sala de
aula, auditório ou
sala de formação

EDUCATION SOLUTIONS



VÁRIOS MODELOS E
MARCAS DISPONÍVEIS
CONSULTE-NOS PARA
MAIS INFORMAÇÕES

elétricos



+
SUSPENSÃO ELÉTRICOS
 MOLDURAS NEGRAS · DROP SUPERIOR
 FORMATO 4:3 · 16:9 · 16:10
 COMANDO IR/RF
 INSTALAÇÃO PAREDE / TETO

Disponível
 150CM A 1200CM

tensionados



+
SUSPENSÃO TENSIONADOS
 MOLDURAS NEGRAS · DROP SUPERIOR
 FORMATO 4:3 · 16:9 · 16:10
 COMANDO IR/RF
 INSTALAÇÃO PAREDE / TETO

Disponível
 200CM A 700CM

encastrar



+
SUSPENSÃO ENCASTRAR
 MOLDURAS NEGRAS · DROP SUPERIOR
 FORMATO 4:3 · 16:9 · 16:10
 COMANDO IR/RF
 INSTALAÇÃO ENCASTRAR

Disponível
 200CM A 700CM

manuals



+
SUSPENSÃO MANUAIS
 MOLDURAS NEGRAS · DROP SUPERIOR
 FORMATO 4:3 · 16:9
 SUBIDA LENTA
 INSTALAÇÃO PAREDE / TETO

Disponível
 150CM A 300CM

tripé



+
TRIPÉ
 MOLDURAS NEGRAS
 CORREÇÃO KEYSTONE
 FORMATO 1:1 · 4:3 · 16:9
 INSTALAÇÃO CHÃO

Disponível
 150CM A 200CM

portáteis



+
PORTÁTEIS / FASTFOLDS
 MOLDURAS NEGRAS · FLIGHT CASE
 (PROJEÇÃO FRONTAL / RETROPROJEÇÃO)
 FORMATO 16:9 (OUTROS SOB CONSULTA)
 INSTALAÇÃO CHÃO

Disponível
 265CM A 608CM





SMART Board®
RX Series | MX Series | GX Series

SMART Learning Suite
online



Software

SMART
Remote Management
ANY DEVICE.
ANY LOCATION.

Software de
Gestão Remota
para Displays
SMART



SMART Board®
Document Camera™ 650
4K





SMART Board®
RX Series | MX Series | GX Series

55" | 65" | 75" | 86"



VÁRIOS MODELOS E
OPÇÕES DISPONÍVEIS
CONSULTE-NOS PARA
MAIS INFORMAÇÕES

INTERACTIVE DISPLAYS

PROFESSIONAL DISPLAYS



+
DISPLAYS INTERATIVOS
VÁRIAS LINHAS
E MODELOS DISPONÍVEIS



Tamanhos
65" | 75" | 86"

+
DISPLAYS PROFISSIONAIS
VÁRIOS MODELOS
DISPONÍVEIS



Tamanhos
55" | 65" | 75" | 86" | 98"

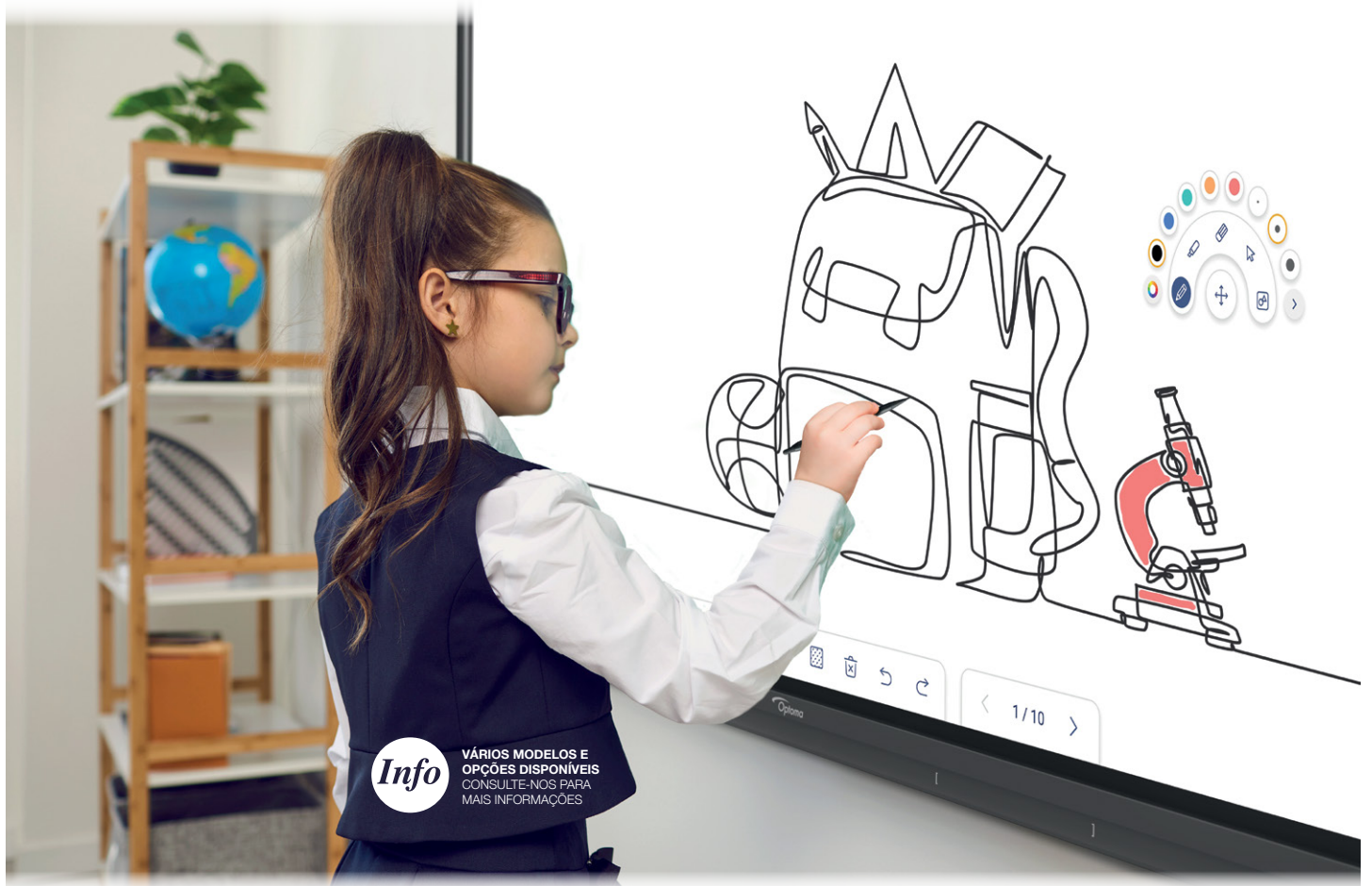

Info VÁRIOS MODELOS E
OPÇÕES DISPONÍVEIS
CONSULTE-NOS PARA
MAIS INFORMAÇÕES

DESKTOP DISPLAYS



+
DISPLAYS DE SECRETÁRIA
 VÁRIOS MODELOS
 E LINHAS DISPONÍVEIS

Tamanhos de
 17" A 34"

LARGE FORMAT



+
DISPLAYS DE GRANDE FORMATO
 VÁRIOS MODELOS
 E LINHAS DISPONÍVEIS

350 cd/m² | **Tamanhos de**
A 2700 cd/m² | **32" A 98"**

ePAPER DISPLAYS



+
DISPLAYS DE SINALIZAÇÃO (SIGNAGE)
 2 MODELOS
 DISPONÍVEIS

Tamanhos
 13.3" | 25.3"



Info VÁRIOS MODELOS E
 OPÇÕES DISPONÍVEIS
 CONSULTE-NOS PARA
 MAIS INFORMAÇÕES

**DIRECT
 VIEW LED**



+
BUNDLES LED WALL
 VÁRIOS MODELOS
 E LINHAS DISPONÍVEIS

0.9mm Pixel | **Tamanhos de**
Pitch A 1.8mm | **108" A 162"**

Tamanhos
32" A 75"



Elegance

MESA INTERATIVA

GARANTE UMA EXPERIÊNCIA VISUAL SEM LIMITES. POSSIBILIDADE DE MÚLTIPLAS APLICAÇÕES COMO WAYFINDING, DIVULGAÇÃO DE CAMPANHAS, VISUALIZAÇÃO DE MAPAS EM 3D, CATÁLOGOS DIGITAIS, ATIVAÇÕES DE MARCA, SIMULADORES INTERATIVOS, VÍDEOS, RECEPCIONISTA VIRTUAL A VISITANTES COM APLICABILIDADE AO SETOR PÚBLICO E/OU PRIVADO, ENTRE OUTROS.

indoor ✓
mobilidade reduzida ✓

Empire

MUPI DIGITAL

TENHA O IMPÉRIO AO SEU ALCANCE... COM A ELEGÂNCIA DO QUIOSQUE EMPIRE A COMUNICAÇÃO FICA FACILITADA GRAÇAS AO SEU DESIGN SIMPLES E SIMULTÂNEAMENTE APELATIVO QUE POTENCIA O FOCO DO UTILIZADOR NO CONTEÚDO EXIBIDO.

COM UMA ÁREA INTERATIVA AMPLA FACE À SUA ESTRUTURA, É GARANTIDO QUE TODAS AS ATENÇÕES SE VÃO VOLTAR PARA O SEU EMPIRE!

indoor ✓



Info VÁRIOS MODELOS E OPÇÕES DISPONÍVEIS. CONHEÇA AS NOSSAS SOLUÇÕES OUTDOOR. CONSULTE-NOS PARA MAIS INFORMAÇÕES

Tamanhos
43" OU 50"



Tribune

PULPITO DIGITAL

DUPLA COMUNICAÇÃO, DUPLA EFICÁCIA. IDEAL PARA APRESENTAÇÕES EM AUDITÓRIOS, POLITÉCNICOS E UNIVERSIDADES. DISPONÍVEL EM 43" (1200X650MM) E 50" (1250X750MM)

indoor ✓

Tamanhos
32" A 75"

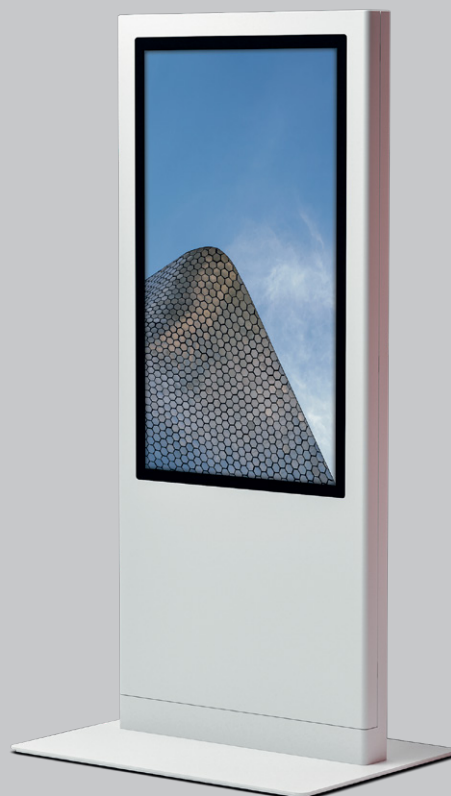

Tamanhos
32" A 86"



Xtreme

MUPI DIGITAL

PROJETADO PARA APLICAÇÃO EM LOCAIS COM CONDIÇÕES METEOROLÓGICAS EXTREMAS.

outdoor ✓

SOLUÇÕES DIGITAL SIGNAGE

SISTEMAS DE MEDIÇÃO DE AUDIÊNCIA

QUIOSQUES DIGITAIS CORPORATE TV

OS SISTEMAS DE CORPORATE TV OU DIGITAL SIGNAGE PERMITEM A CRIAÇÃO E GESTÃO DE CONTEÚDOS MULTIMÉDIA (IMAGENS, VÍDEOS, NOTÍCIAS, CONTEÚDOS WEB, ETC.) E A SUA DISPONIBILIZAÇÃO POR UM OU VÁRIOS DISPLAYS.

ESTES PODEM ESTAR NO MESMO LOCAL ONDE ESTÁ INSTALADO O **SOFTWARE** OU ENTÃO ESTAR EM LOCAIS REMOTOS. A ATUALIZAÇÃO DOS CONTEÚDOS PODE SER EFETUADA DE FORMA REMOTA, PERMITINDO DESTA FORMA QUE AS ATUALIZAÇÕES DE CONTEÚDOS EM DEZENAS OU MESMO CENTENAS DE DISPLAYS POSSAM SER EFETUADAS DE FORMA EFICAZ E EM POUCOS SEGUNDOS.

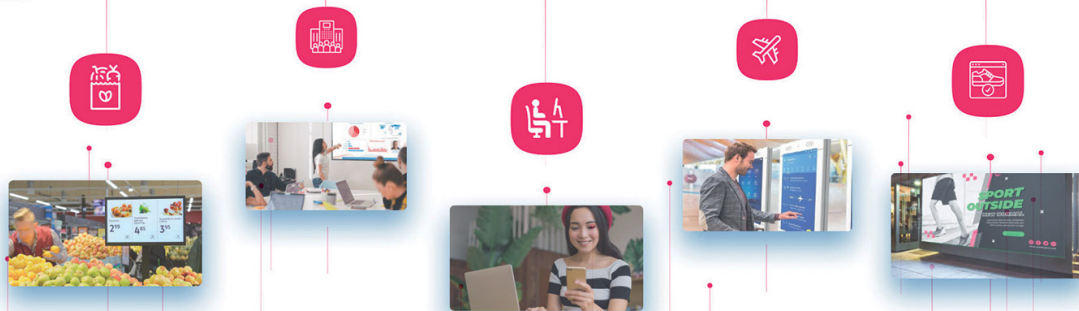
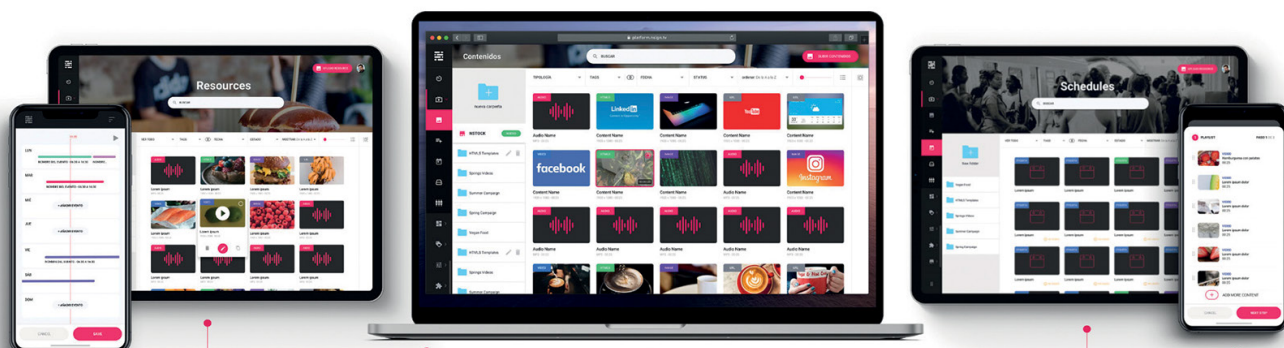

PRINCIPAIS ÁREAS
EDUCAÇÃO
SAÚDE
CORPORATE
TURISMO
COMÉRCIO E RETALHO
MERCADO FINANCEIRO



PODE SER UTILIZADO 
 EM DIVERSOS LOCAIS
 E COM DIVERSAS
 FUNCIONALIDADES.
CAMPANHAS OUTDOOR
PONTOS DE INFORMAÇÃO
E LOCAIS DE GRANDE
AFLUÊNCIA DE PÚBLICO.

06. SOLUÇÕES COLABORATIVAS



Broadcaster 4K AI

The 4K production camera with smart tracking

Broadcaster 12x/20x AI

The best value for money on the market

T-Pod Air Pro Beamforming

Intelligent voice tracking



CÂMARA BROADCASTER 4K

4K UHD
12X ZOOM ÓTICO | AI TRACKING
INCLUI HDMI | SDI | USB 3.0 | LAN | NDI®|HX E SRT

CÂMARA BROADCASTER 12X/20X AI

1080P 60FPS
12 /20X ZOOM ÓTICO | AI TRACKING
INCLUI HDMI | SDI | USB 3.0 | LAN | NDI®|HX E SRT

MICROFONE PROFISSIONAL DE TETO / PAREDE

IDEAL PARA DISTÂNCIAS ATÉ 8M.
7 MICROS COM TECNOLOGIA BEAMFORMING.
CONEXÃO USB, MINI JACK.



+ COMPATÍVEL COM MÚLTIPLAS PLATAFORMAS

zoom
 go facing
 Google Meet
 pexip

Blackmagic design
 vMix
 NewTek
 OBS Open Broadcaster Software
 WOWZA media systems

nureva
 biamp
 BARCO
 Dante
 NDI-HX



B&H PC Pro FHD

It's powerfull, it's portable, it's Plug & Play



CÂMARA PORTÁTIL ALL-IN-ONE
 DUPLO MICRO 180°
 CONEXÃO USB-A / USB-C



Cute 4K AI

Focus on communicating



CÂMARA PTZ 4K
 CÂMARA 4K | AI TRACKING | ZOOM ÓTICO 12X
 CONEXÃO HDMI | USB 3.0 | LAN



Cute UP 4K Pro

All-in-one AV bar for your meetings



CÂMARA DE CONFERÊNCIA ALL-IN-ONE
 CÂMARA 4K | MICROFONE BEAMFORMING
 COLUNA 96dB | CONEXÃO HDMI | USB-C | USB



Cute Bullet 4K AI

4K quality for all situations



CÂMARA EPTZ
 CÂMARA 4K | AI TRACKING
 CONEXÃO HDMI | USB 3.0 | LAN



Cute 12/20x AI

For medium to large meeting rooms



CÂMARA PTZ
 ZOOM ÓTICO 12X OU 20X | AI TRACKING
 CONEXÃO HDMI | USB 3.0 | LAN



Software

AI integration



INTELIGÊNCIA ARTIFICIAL PARA AS SUAS CÂMARAS
 FUNCIONALIDADES DE VÍDEO AVANÇADAS PARA
 CÂMARAS LAIA OU DE OUTRAS MARCAS



CONSEGUIR O CONTROLO TOTAL DA CÂMARA A
 PARTIR DE UM ADMINISTRADOR ÚNICO NUNCA
 FOI TÃO FÁCIL.
 IDEAL PARA GRANDES IMPLEMENTAÇÕES:
 ADMINISTRAÇÃO PÚBLICA, EMPRESAS, ENSINO...

T-Pod WiFi / Dual

Small meeting room's



MICROFONE WIFI COM COLUNA
 CONEXÃO WIFI VIA DONGLE USB
 3 MICROS OMNIDIRECIONAIS
 MODELO DUAL (INCLUI 2 SPEAKERPHONES)



T-Pod Quad22

Any meeting room's



SISTEMA DE QUATRO MICROFONES WIFI
 CONEXÃO WIFI VIA
 T-POD MASTER



AUTOMATIZA O ENQUADRAMENTO DE UMA OU
 VÁRIAS CÂMARAS TRABALHANDO COM MARCAS
 DE ÁUDIO DE TERCEIROS, COMO A NUREVA





MICROFONES DE TETO

360° OMNIDIRECCIONAL
CAPTAÇÃO DE 10 METROS POR MICROFONE
OPÇÃO DUAL COM 2 MICROFONES OU QUAD COM 4 MICROFONES



T-Pod Air Pro Dual

KIT INCLUI
1 PROCESSADOR DIGITAL DE SINAL (UNIDADE CENTRAL)
2 MICROFONES OMNIDIRECCIONAIS
ACESSÓRIOS NECESSÁRIOS



DIAGRAMA DE LIGAÇÕES T-POD DUAL

Sistemas AV não incluídos

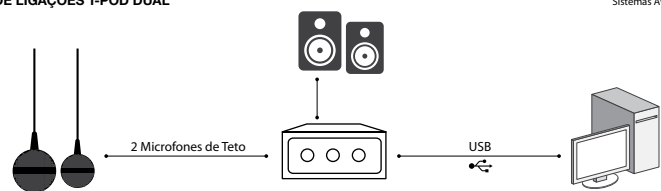

+ de 300 salas instaladas
COM TECNOLOGIA / PRODUTOS LAIA®



T-Pod Air Pro Quad

KIT INCLUI
1 PROCESSADOR DIGITAL DE SINAL (UNIDADE CENTRAL)
4 MICROFONES OMNIDIRECCIONAIS
ACESSÓRIOS NECESSÁRIOS



DIAGRAMA DE LIGAÇÕES T-POD QUAD

Sistemas AV não incluídos

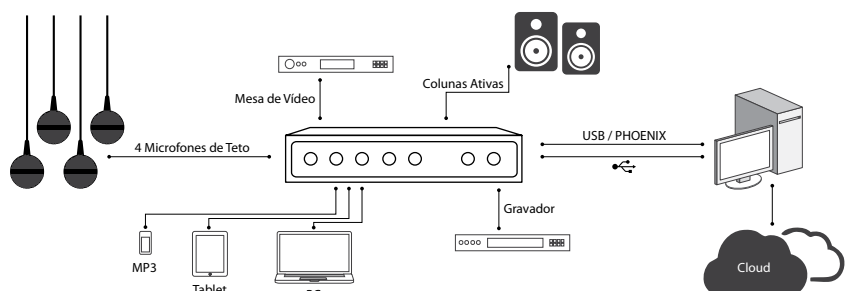



MULTI-CÂMARA LAYOUT PERSONALIZADOS

MVC Series

Microsoft Teams Rooms (MTR)

 Certified for
Microsoft Teams



Teto (Encastrar)



Teto



Mesa



Wireless



KIT INCLUI

- 2 CÂMARAS
- 1 PAINEL TOUCH
- 1 HUB
- 1 MINI PC
- 1 ROOMSENSOR
- 1 MVC-BYOD-EXTENDER
- 2 APRESENTADORES WIRELESS

CAPACIDADE DE EXPANSÃO

- ATÉ 9 CÂMARAS
- ATÉ 8 MICROFONES
- ATÉ 4 COLUNAS DE ÁUDIO



SISTEMA NATIVO MICROSOFT TEAMS PARA SALAS DE GRANDE DIMENSÃO.

INCLUI DUAS CÂMARAS USB PTZ COM ZOOM ÓTICO DE 12X, OFERECENDO-LHE UMA SOLUÇÃO MULTI-CÂMARA QUE SUPORTA AJUSTES E DISPOSIÇÃO DAS MESMAS PARA SATISFAZER OS REQUISITOS DE SALAS DE GRANDE DIMENSÃO. OPÇÃO DE CÂMARAS AUTO-TRAKING.



VÁRIOS MODELOS E PRODUTOS DISPONÍVEIS
CONSULTE-NOS PARA MAIS INFORMAÇÕES

BYOD MEETING KITS

AMPLA GAMA DE SISTEMAS PLUG AND PLAY



UVC84-BYOD-210

KIT INCLUI

- 1 CÂMARA UVC84
- 1 MSPEAKER II SOUNDBAR
- 2 VCM34 MICROPHONE



All-in-one
Plug and Play



Custo
Efetividade



Implementação
Simples



UVC84-BYOD-050

KIT INCLUI

- 1 CÂMARA UVC84
- 1 SPEAKERPHONE MSPEECH USB
- 1 BYOD BOX



All-in-one
Plug and Play



Custo
Efetividade



Implementação
Simples



UVC40-BYOD

KIT INCLUI

- 1 UVC40 ALL-IN-ONE USB VIDEO BAR
- 1 BYOD BOX
- 1 VCR20 REMOTE CONTROL



All-in-one
Plug and Play



Custo
Efetividade



Implementação
Simples

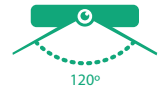

UVC34

KIT INCLUI

- 1 UVC34 ALL-IN-ONE USB VIDEO BAR
- 1 VCR20 REMOTE CONTROL



All-in-one
Plug and Play



Custo
Efetividade



Implementação
Simples

ZOOM ROOMS

MICROSOFT TEAMS ROOMS

BARRA DE COLABORAÇÃO DE VÍDEO ALL-IN-ONE ANDROID



A20

KIT INCLUI

- 1 ALL-IN-ONE COLLABORATION BAR A20
- 1 PAINEL TOUCH CTP18



All-in-one Plug and Play



WPP30

APRESENTADOR WIRELESS | PARTILHA DE CONTEÚDOS
VÍDEOCONFERÊNCIA SEM FIOS



Apresentação com um toque



All-in-one Plug and Play

A30

KIT INCLUI

- 1 ALL-IN-ONE COLLABORATION BAR A30
- 1 PAINEL TOUCH CTP18

SOLUTIONS

QUAL O TAMANHO DA SUA SALA?



Focus / Huddle



Small



Medium



Large



Training / Classroom



MVC320



MVC400



MVC640



MVC840



MVC940

MeetingBoard

FANTASTIC MEETINGS ON BOARD

Meet, Share and Collaborate with MeetingBoard

Certified for
Microsoft Teams

Zoom Certified

Standalone
Device mode





Info

VÁRIOS MODELOS E OPÇÕES DISPONÍVEIS
CONSULTE-NOS PARA MAIS INFORMAÇÕES





+ **AV Bridge Mini**
AV BRIDGES

**EXTEND IT
BRIDGE IT
STREAM IT**

INTEGRA FONTES AV NO
SEU PC VIA USB 3.0

USA TECNOLOGIA
HDBaseT

SAÍDA USB
ATÉ 1080P / 60

**USB Collaboration
AV Bridges
Professional Cameras
Controls & Switchers**



CONECTE-SE, COLABORE E
COMPARTILHE SEM FIOS.



MYTEAM SHARER



**SISTEMA DE APRESENTAÇÃO E
VÍDEOCONFERÊNCIA SEM FIOS.**

BYOD & BYOM
APRESENTAÇÃO SIMULTÂNEA ATÉ 4 DISPOSITIVOS
FUNCIONA COM QUALQUER DISPOSITIVO E QUALQUER MARCA
COLABORE COM O BOTÃO DE CONFERÊNCIA OU APLICATIVO DE COLABORAÇÃO
REUNIÕES HÍBRIDAS SEM FIOS
AIRPLAY | MIRACAST | CHROMECAST
RESOLUÇÃO 4K60 (COM DONGLE HDMI)

+
DONGLE USB-C OU
HDMI TOUCH&PLAY
(OPCIONAL)



ClickShare

BARCO CLICKSHARE



**SISTEMA DE APRESENTAÇÃO E
VÍDEOCONFERÊNCIA SEM FIOS.**

SUPORTE TOTAL PARA BYOD (BRING YOUR OWN DEVICE)
COLABORAÇÃO REMOTA
FUNCIONA COM QUALQUER DISPOSITIVO E QUALQUER MARCA
COLABORE COM O BOTÃO DE CONFERÊNCIA OU APLICATIVO DE COLABORAÇÃO
REUNIÕES HÍBRIDAS SEM FIOS
AIRPLAY | MIRACAST | GOOGLECAST
RESOLUÇÃO 4K UHD



VÁRIOS MODELOS DISPONÍVEIS DE ACORDO COM AS SUAS NECESSIDADES
CONSULTE-NOS PARA MAIS INFORMAÇÕES

06. SOLUÇÕES COLABORATIVAS



+ AM-TX3-100



ONE CONNECTION. ONE BUTTON-PRESS. ONE SIMPLE BYOD SOLUTION.

SISTEMAS DE APRESENTAÇÃO E VÍDEOCONFERÊNCIA SEM FIOS



AM-3200

AirMedia® Receiver 3200 Wi-Fi®



RESOLUÇÃO 4K.
PERMITE COLABORAÇÃO COM OU SEM FIOS.
FÁCIL DE INSTALAR E GERIR.
CONEXÃO HDMI® COM FIO OU CONEXÃO AIRMEDIA® SEM FIOS.
MICRO-SD CARD SLOT PARA DIGITAL SIGNAGE.
DUAL LAN, SAÍDA DE ÁUDIO BALANCEADA, HDMI INPUT, CEC, IR, RS-232, IP. POE+.

AM-3100

AirMedia® Receiver 3100 Wi-Fi®



RESOLUÇÃO 4K.
PERMITE COLABORAÇÃO COM OU SEM FIOS.
FÁCIL DE INSTALAR E GERIR.
MICRO-SD CARD SLOT PARA DIGITAL SIGNAGE.
HDMI OUTPUT.
BYOD & BYOM.
POE+.

AM-TX3-100

AirMedia® Series 3 Connect Adaptor



RESOLUÇÃO 4K.
ADAPTADOR (DONGLE) USB-C PARA APRESENTAÇÕES E VÍDEOCONFERÊNCIAS SEM FIOS.
NECESSÁRIO EMPARELHAR COM UM RECEPTOR AIRMEDIA SÉRIE 3 COMPATÍVEL COM REDE WI-FI®.



VÁRIAS OPÇÕES DISPONÍVEIS.
CONSULTE-NOS PARA
MAIS INFORMAÇÕES

PERFECT SOLUTION FOR MEETING ROOMS & CLASSROOMS

SISTEMAS DE CONTROLO SIMPLES E ECONÓMICOS



LITECUE-TAP

liteCUE-basic

Button keypad as a control panel



KIT DE CONTROLO SIMPLES E ECONÓMICO. INTERFACE DE UTILIZADOR INTUITIVO FORNECIDO PELO TECLADO CUE-55. SOLUÇÃO PERFEITA PARA CONTROLO AV, BEM COMO PARA CONTROLO DE AMBIENTE. ADEQUADO PARA SALAS DE DIREÇÃO, SALAS DE REUNIÕES, SALAS DE AULA, ETC...

liteCUE-tap

Touch-screen as a control panel



SOLUÇÃO COMPLETA E FÁCIL DE UTILIZAR PARA CONTROLO DE SALAS. DISPLAY TOUCH COM MÁXIMO DE 32 BOTÕES. INSTALAÇÃO EM MESA OU NA PAREDE. SUPORTE POTENTE PARA CONTROLO DE DISPOSITIVOS IP, SÉRIE E IR. FONTE DE ALIMENTAÇÃO POWER OVER ETHERNET.

liteCUE-web

Mobile device as a control panel



LICENÇA ÚNICA PARA CONTROLO WEB E APLICAÇÃO DE RESERVA DE SALAS. APLICAÇÃO WEB ACTIVADA ATRAVÉS DA LEITURA DE UM CÓDIGO QR. COMPATÍVEL COM TODAS AS PLATAFORMAS MÓVEIS. COMPRA ÚNICA DE LICENÇA. TUDO CONTROLADO A PARTIR DO CONFORTO DO SEU PRÓPRIO DISPOSITIVO PESSOAL.

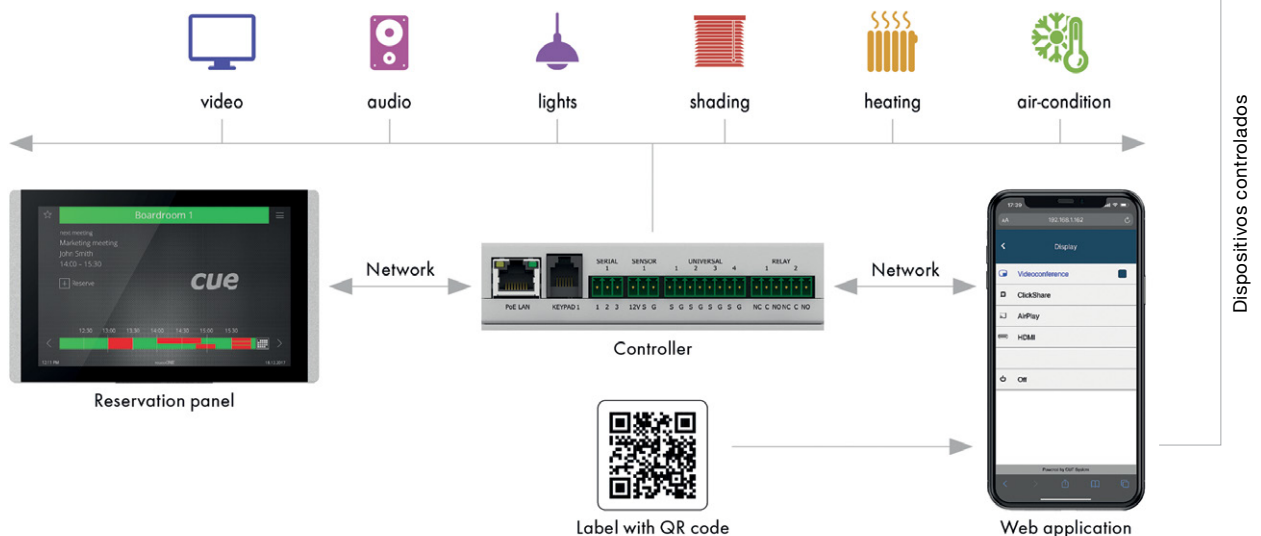

EFFICIENT COMMUNICATION

SOFTWARE TRANSCRIÇÃO DE FALA

TRANSFORME UMA
GRAVAÇÃO DE ÁUDIO
DIGITAL NUM FICHEIRO
DE TEXTO



MEDIA FILE



PROCESSING



XML METADATA

CONSULTE-NOS PARA MAIS INFORMAÇÕES

TELEVIC CONFERENCE LEADING EXPERT IN CONFERENCING TECHNOLOGY



+
UNICOS T/MM10
UNICOS 10" TABLETOP
MULTIMEDIA UNIT

+
CONFIDEA FLEX
CONFIGURABLE CONFERENCE
UNIT WITH TOUCH SCREEN

+
D-CERNO
DISCUSSION UNIT WITH
REMOVABLE MICROPHONE

+
INTERPRETER DESK
MULTILINGUAL MEETING
MANAGEMENT



XTOUCH
PAINEL TOUCH 8"

BIGGER SPACES DON'T HAVE TO
MEAN BIGGER HEADACHES.

ESPAÇOS MAIORES NÃO SIGNIFICAM MAIORES DORES DE CABEÇA.

COLLABORATION SOLUTIONS

SOLUÇÕES PARA SALAS DE AULA OU DE FORMAÇÃO



XSB-MEDIUM

XILICA X SENNHEISER MEDIUM ROOM KIT

KIT INCLUI

XILICA SOLARO QR1 UC PROCESSOR
COLUNAS DE ENCASTRAR DE TETO XILICA SONIA C5 (X2)
AMPLIFICADOR XILIXA SONIA AMP
MICROFONE DE TETO SENNHEISER TEAMCONNECT CEILING 2



XSB-LARGE

XILICA X SENNHEISER LARGE ROOM KIT

KIT INCLUI

XILICA SOLARO QR1 UC PROCESSOR + PAINEL TÁTIL
COLUNAS DE ENCASTRAR DE TETO XILICA SONIA C5 (X4)
AMPLIFICADOR XILIXA SONIA AMP
MICROFONE DE TETO SENNHEISER TEAMCONNECT CEILING 2

XILICA®

 **SENNHEISER**

VÁRIOS BUNDLES E PRODUTOS DISPONÍVEIS DE ACORDO COM AS SUAS NECESSIDADES
CONSULTE-NOS PARA MAIS INFORMAÇÕES



HOWEVER YOU CHOOSE TO DEPLOY PROCESSING, SOLARO PROVIDES A RIGHT SIZE FOR YOUR ROOM.

SCALABLE ROOM PROCESSING BUILT FOR THE NETWORK.

SOLARO SERIES



QR1

PROCESSADOR DE SINAL DIGITAL (DSP)
 CONFIGURAÇÃO DE ARQUITETURA ABERTA - PoE
 OFERECE 8 RANHURAS PARA CARTAS CONFIGURÁVEIS
 (ÁUDIO ANALÓGICO, USB, GPIO, RELÉS, ÁUDIO DIGITAL AES/EBU)
 REDE DE ÁUDIO DANTE NATIVA COM 4X4 CANAIS

FR1

PROCESSADOR DE SINAL DIGITAL (DSP)
 CONFIGURAÇÃO DE ARQUITETURA ABERTA
 OFERECE 16 RANHURAS PARA CARTAS CONFIGURÁVEIS
 (ÁUDIO ANALÓGICO, USB, GPIO, RELÉS, ÁUDIO DIGITAL AES/EBU)
 REDE DE ÁUDIO DANTE OPCIONAL COM 64X64 CANAIS



CONTROLORES DE PAREDE

VÁRIOS PRODUTOS DISPONÍVEIS COM UM INCRÍVEL DESIGN.

LUCIA | XTOUCH



CARTAS

OS PROCESSADORES SOLARO PODEM SER PREENCHIDOS COM DIFERENTES CARTAS I/O PARA FORNECER A CORRESPONDÊNCIA DE REQUISITOS PARA SUA APLICAÇÃO, PERMITINDO QUE OS SISTEMAS SEJAM DIMENSIONADOS E O CICLO DE VIDA DOS PRODUTOS AMPLIADOS.



Info

VÁRIOS MODELOS E PRODUTOS DISPONÍVEIS
CONSULTE-NOS PARA MAIS INFORMAÇÕES

AUDITÓRIOS | FORMAÇÃO | SALAS DE AULAS

MX-0804-EDC

8X4 MULTI-INPUT MATRIX

CONEXÃO DE VIDEO MULTI-FORMATO (USB-C E HDMI)
AUDIO DSP E DANTE

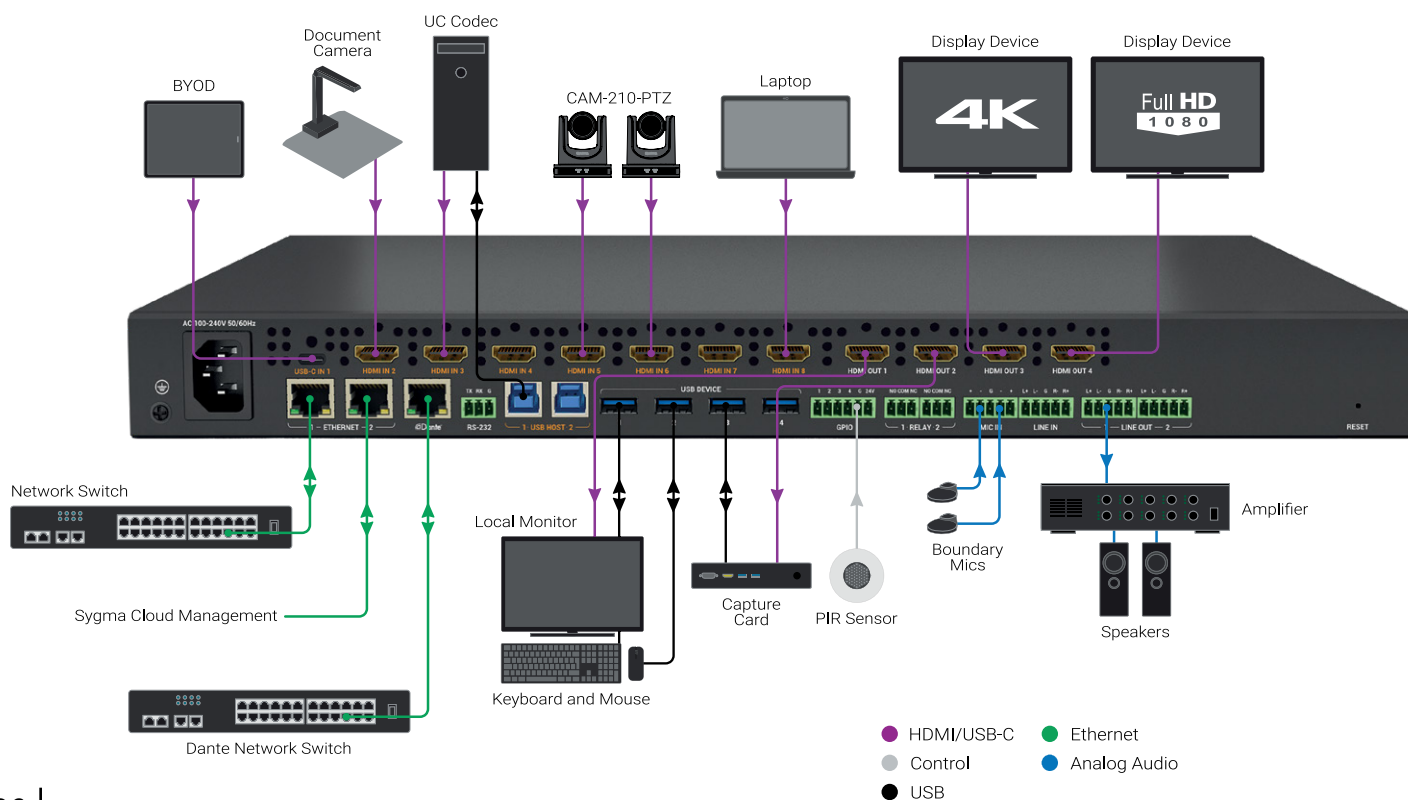

SYNERGY PRESENTATION SOLUTIONS

DYNAMIC SWITCHING, OUT OF SIGHT & OUT OF MIND

SW-640L-TX-W

4X2 4K SWITCHER WITH WIRELESS CASTING & MST HUB
 2 HDMI / 2 USB-C INPUTS SUPPORTING ALT-MODE FUNCTIONS
 USB 3.0 HOST FOR HDMI AND USB-C WITH ADDITIONAL 65W CHARGING
 4K WIRELESS SCREENSHARING VIA APPLE AIRPLAY | MIRACAST | CHROMECAST | APO-DG2
 2 ETHERNET INTERFACES FOR ADDITIONAL NETWORK SECURITY

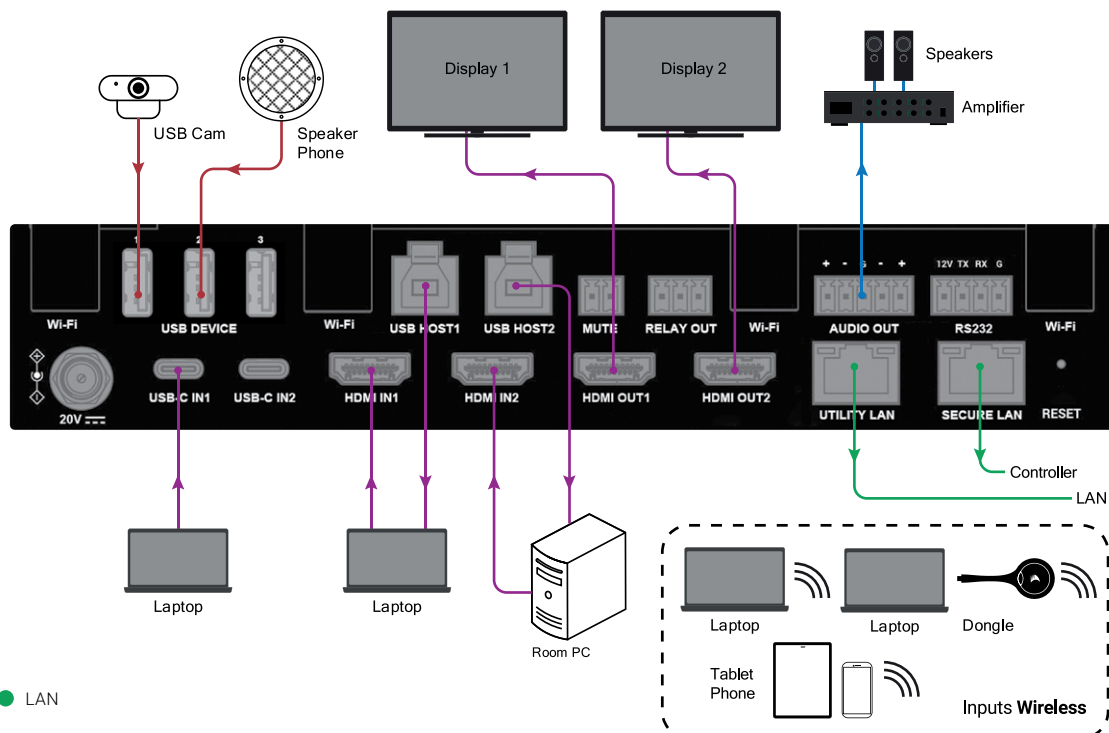

GRAVAÇÃO E STREAMING

AN END-TO-END SOLUTION FOR RECORDING AV PRESENTATIONS FROM SCHEDULING TO LIVE STREAMING AND PUBLISHING



COMO GRAVAR E FAZER STREAMING EM TEMPO REAL?

CONSEGUIMOS PESQUISAR POR TÍTULO, DATA, AUTOR?

COMO ARQUIVAR OS FICHEIROS?

A GAMA SMP300 DÁ RESPOSTA A TODAS AS SUAS PERGUNTAS!



SMP 300 Series

Extron SMP 351
Streaming Media Processor

EXEMPLO DO DIAGRAMA DE LIGAÇÕES

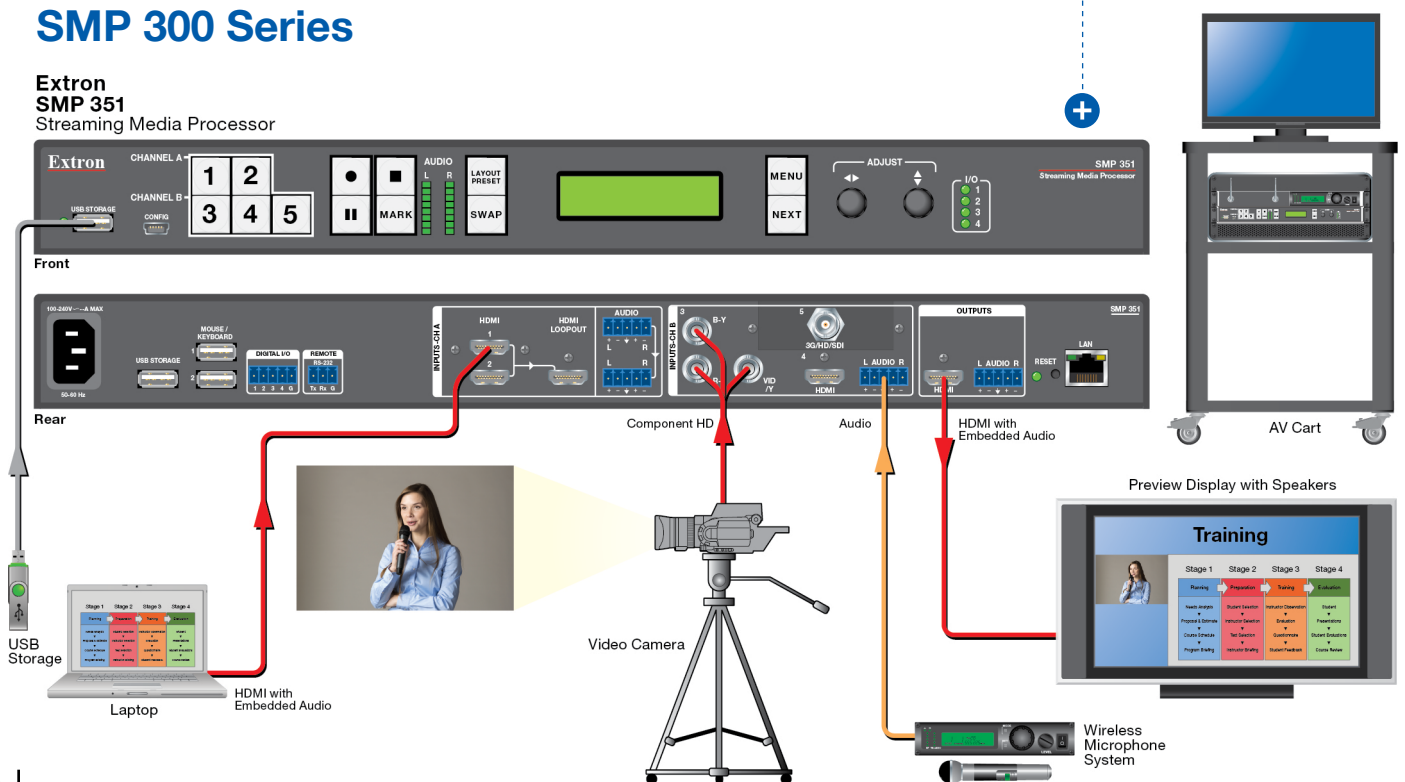



Info

VÁRIOS BUNDLES E PRODUTOS DISPONÍVEIS DE ACORDO COM AS SUAS NECESSIDADES
CONSULTE-NOS PARA MAIS INFORMAÇÕES

PORTABLE VIDEO STREAMING STUDIO



BDL-1601

BUNDLE INCLUI

- 1X HS-1600T
- UNIDADE DE PRODUÇÃO PORTÁTIL
- 3X PTC-140T
- CÂMARA PTZ FULL HD
- 1X HC-800 (FLIGHTCASE)



BDL-1602

BUNDLE INCLUI

- 1X HS-1600T
- UNIDADE DE PRODUÇÃO PORTÁTIL
- 3X PTC-150TL
- CÂMARA PTZ HD/SD
- 1X HC-800 (FLIGHTCASE)



BDL-1603

BUNDLE INCLUI

- 1X HS-3200
- UNIDADE DE PRODUÇÃO PORTÁTIL
- 3X PTC-140 (CÂMARA PTZ FULL HD)
- RMC-300A (CONTROLADOR)
- 1X HC-800 (FLIGHTCASE)

CAP-1

SDI TO USB 3.0 CAPTURE BOX

DISPOSITIVO PROFISSIONAL PARA CAPTURA DE VÍDEO EM ALTA VELOCIDADE.



CAP-2

HDMI TO USB 3.0 CAPTURE BOX

DISPOSITIVO PROFISSIONAL PARA CAPTURA DE VÍDEO EM ALTA VELOCIDADE.



PROFISSIONAL CAMCORDERS

AMPLA GAMA DE CÂMARAS DE MÃO PARA VÍDEO PROFISSIONAL



TRIPÉS / ILUMINAÇÃO

COMPACTOS, LEVES E PORTÁTEIS



GESTÃO DE TEMPOS

SOFTWARE DE GESTÃO DE TEMPOS
O SEU CONTADOR DIGITAL

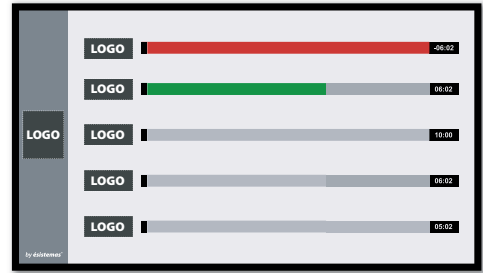

GESTÃO EM
BACK OFFICE

datavideo

TELEPROMPTER

SISTEMA DE TELEPONTO
PARA CÂMARAS



TELEPROMPTER

SISTEMA DE TELEPONTO
PORTÁTIL



INTERCOM

SISTEMAS DE
INTERCOMUNICAÇÃO



SISTEMAS DE PRODUÇÃO DE VÍDEO



VÁRIAS SOLUÇÕES E PRODUTOS DISPONÍVEIS
CONSULTE-NOS PARA MAIS INFORMAÇÕES



CHARGING STATION ARMÁRIOS DE CARREGAMENTO



E12

ARMÁRIO DE CARREGAMENTO (12 DISPOSITIVOS)
TABLETS, PORTÁTEIS, CHROMEBOOKS (ATÉ 15,6")



E32c

CARRINHO DE CARREGAMENTO (32 DISPOSITIVOS)
TABLETS, PORTÁTEIS, CHROMEBOOKS (ATÉ 14")



eltax

Bluetooth®

ÁUDIO PORTÁTIL WIRELESS ALL-IN-ONE

COLUNA / AMPLIFICADOR PORTÁTIL COM COMANDO À DISTÂNCIA,
BLUETOOTH E MICROFONE DE MÃO WIRELESS

TODOS OS MODELOS
INCLUEM 2 MICROFONES
DE MÃO WIRELESS,
COMANDO, RODAS
E PEGA PARA FÁCIL
TRANSPORTE



Voyager BT12 MKII

POTÊNCIA 350W
DIMENSÕES 335X520X320MM



Voyager BT15 MKII

POTÊNCIA 450W
DIMENSÕES 435X610X360MM



Voyager BT15 Pro MKII

POTÊNCIA 500W
DIMENSÕES 330X810X415MM



ÁUDIO PORTÁTIL PROFISSIONAL PORTABLE PA SYSTEMS

STAGEPAS 400BT / 600BT

SISTEMA DE SOM PORTÁTIL ALL-IN-ONE STAGEPAS

2 COLUNAS PASSIVAS + PA

POTÊNCIA DE 400W (200W + 200W) **400BT**

POTÊNCIA DE 680W (340W + 340W) **600BT**

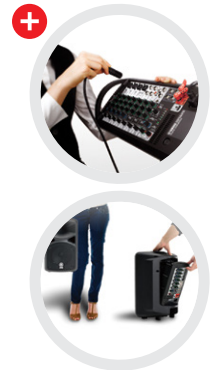

ÁUDIO PORTÁTIL PROFISSIONAL ALL-IN-ONE PORTABLE PA SYSTEMS

STAGEPAS 1K

SISTEMA DE SOM PORTÁTIL ALL-IN-ONE STAGEPAS

PA + COLUNA LINE ARRAY

POTÊNCIA DE 1000W (190W + 810W)

CONEXÃO BLUETOOTH

DIGITAL MIXER



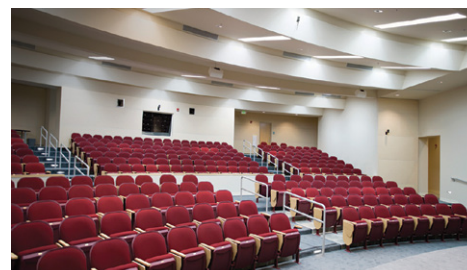

PCR 5T / 8T

COLUNAS DE ENCASTRAR DE TETO PASSIVAS
 POTÊNCIA 25W (PCR 5T) 35W (PCR 8T)
 TRANSFORMADOR DE 100V INTEGRADO
 DIMENSÕES Ø200MM X 70MM (PCR 5T)
 DIMENSÕES Ø250MM X 95MM (PCR 8T)



W
RAL 9016

PowerBox 51/61

COLUNAS DE PAREDE ATIVAS
 POTÊNCIA 2X20W (PB51), 2X30W (PB61)
 FREQUÊNCIA DE RESPOSTA 120 HZ - 20 KHZ (PB51)
 FREQUÊNCIA DE RESPOSTA 80 HZ - 20 KHZ (PB61)



W B
RAL 9016 RAL 9017

iLive2

MICROFONE DE MÃO/CABEÇA/LAPELA SEM FIOS
 SISTEMA WIRELESS COM 32 CANAIS SELECIONÁVEIS
 MICROFONE DE MÃO/CABEÇA/LAPELA WIRELESS
 FREQUÊNCIA DE RESPOSTA 45 HZ - 18 KHZ



VIVA 4 / 5

COLUNAS DE PAREDE PASSIVAS
 POTÊNCIA 20W (VIVA 4) 30W (VIVA 5)
 IMPEDÂNCIA 8 OHMS
 DIMENSÕES 205 X 188 X 132MM (VIVA 4)
 DIMENSÕES 245 X 175 X 170MM (VIVA 5)
 INCLUI SUPORTES



B W
RAL 9017 RAL 9016

PCR 5 / 8

COLUNAS DE ENCASTRAR DE TETO PASSIVAS
 POTÊNCIA 25W (PCR 5) 35W (PCR 8)
 FREQUÊNCIA DE RESPOSTA 80 HZ - 20 KHZ (PCR 5)
 FREQUÊNCIA DE RESPOSTA 60 HZ - 20 KHZ (PCR 8)
 DIMENSÕES Ø200MM X 70MM (PCR 5)
 DIMENSÕES Ø250MM X 95MM (PCR 8)



W
RAL 9003

RF55

COLUNA
 POTÊNCIA 250W RMS
 SENSIBILIDADE 94dB
 FREQUÊNCIA DE RESPOSTA 92 HZ - 20 KHZ



B
RAL 9017

DMPA 60 LIGHT

AMPLIFICADOR MISTURADOR ÁUDIO
 POTÊNCIA (30W)
 FREQUÊNCIA DE RESPOSTA 50 HZ - 20 KHZ
 DIMENSÕES 280X233X75MM
 INPUTS: 2 X XLR, 1 X PHOENIX, 6,3 MM JACK / RCA



05 WALL MOUNT

COLUNAS DE PAREDE
 POTÊNCIA 40W RMS
 FREQUÊNCIA DE RESPOSTA 80 HZ - 20 KHZ
 DIMENSÕES 230 X 160 X 180MM
 PROTEÇÃO IP55



W B
RAL 9016 RAL 9017

RFS12

SUBWOOFER
 POTÊNCIA 350W RMS
 WOOFER DE 12"
 FREQUÊNCIA DE RESPOSTA 33 - 160 HZ (-5 DB)



VÁRIOS MODELOS E OPÇÕES DISPONÍVEIS
 CONSULTE-NOS PARA MAIS INFORMAÇÕES

ACESSÓRIOS PARA INSTALAÇÕES

TECHCONNECT

CAIXAS DE LIGAÇÕES PARA INSTALAÇÕES AV
VÁRIAS CONFIGURAÇÕES DISPONÍVEIS



VÁRIAS CAIXAS
DISPONÍVEIS



CABOS TECHCONNECT PARA CAIXAS VISION
RÁPIDA CONEXÃO AO MÓDULO



TC3-CTL

MÓDULO UNIVERSAL DE CONTROLO
VIA IR, RS-232, RS-485. 12V.
COMANDOS PROGRAMÁVEIS



DOCKING STATION

USB-C® 9-IN-1 DUAL DISPLAY DOCKING STATION
HDMI, ETHERNET, USB, 3.5MM AUDIO
POWER DELIVERY UP TO 60W - 4K 30HZ



ADAPTER RING

UNIVERSAL 4K HDMI® ADAPTER RING
MINI DISPLAYPORT™, DISPLAYPORT,
USB-C®, VGA SERIES



Thunderbolt™ 4 USB-C®

CABOS USB-C®
THUNDERBOLT™ 4 USB-C® (40GBPS)



C2G®

EXTENSOR USB 3.0

HIGH PERFORMANCE USB 3.0 EXTENDER
ATÉ 100M / POC / 1X USB-C / 4X USB A
(USB 3.0 COMPATÍVEL), RS-232 PASS THROUGH,
ÁUDIO BI-DIRECIONAL



C2G®

EXTENSOR HDMI/HDBaseT

100M 4K30 HDBASET EXTENDER
EXTENSOR DE SINAL HDMI/HDBASET
ATÉ 100M (4K30)



C2G®

EXF-300-H2

300M 4K60 FIBER HDMI EXTENDER
EXTENSOR DE SINAL HDMI
ATÉ 300M (4K60)



Solutions

WyreStorm

WyreStorm

MATRIZES HDMI/HDBaseT

HIGH PERFORMANCE MATRIX SWITCHER
DE 4X4 A 8X8 OU OPÇÕES CUSTOMIZADAS
OPÇÕES DE SAÍDA HDMI OU HDBASET



SW-220-TX-W

4K PRESENTATION SWITCHER
HDMI+USB-C+WIRELESS SHARING (AIRPLAY+MIRACAST)
USB 3.0 HUB TO SHARE CAM+MIC WITH USB-C INPUT





BASE DE TETO
INCLUI TAMPA DECORATIVA

COLUNA EXTENSÍVEL
3 TAMANHOS | 30-45CM, 45-80CM, 80-135CM



11 KG
MAX

B

W

all in one
solution
**PIN CONNECT
PROJECTOR MOUNT**

SUPORTE
PARA FIXAÇÃO DO VÍDEOPROJETOR

VERTICAL & PORTRAIT PROJECTOR MOUNT



VPAU

SUPORTE UNIVERSAL DE TETO
IDEAL PARA PROJEÇÕES VERTICAIS.
(COLUNA E BASE DE TETO OPCIONAL)

B W

LARGE FORMAT DISPLAYS

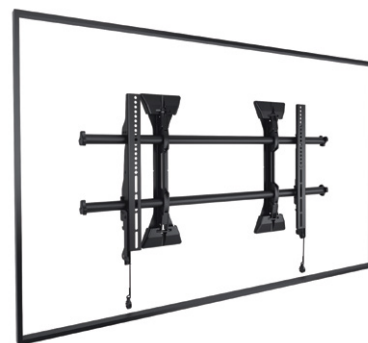

LSM1U

SUPORTE UNIVERSAL DE PAREDE
COMPATÍVEL COM DISPLAYS DE 37" a 63"
MÁXIMO VESA 880 x 500mm
VÁRIOS MODELOS E OPÇÕES DISPONÍVEIS

DISPLAY
63" MAX

B

XSM1U

SUPORTE UNIVERSAL DE PAREDE
COMPATÍVEL COM DISPLAYS DE 55" a 82"
MÁXIMO VESA 1070 x 600mm
VÁRIOS MODELOS E OPÇÕES DISPONÍVEIS

DISPLAY
82" MAX

B

VÁRIAS
SOLUÇÕES
PARA
MÚLTIPLOS
DISPLAYS

+ LCM2X1U



DISPLAY
80" MAX

B

S

MPAU

SUPORTE UNIVERSAL DE CHÃO COM RODAS
COMPATÍVEL COM DISPLAYS DE 37" a 55"
MÁXIMO VESA 600 x 400mm
ALTURA AJUSTÁVEL (127-177cm)
VÁRIOS MODELOS E OPÇÕES DISPONÍVEIS

LPAU

SUPORTE UNIVERSAL DE CHÃO COM RODAS
COMPATÍVEL COM DISPLAYS DE 40" a 80"
MÁXIMO VESA 800 x 400mm
ALTURA AJUSTÁVEL (127-177cm)
VÁRIOS MODELOS E OPÇÕES DISPONÍVEIS



MFAU

SUPORTE UNIVERSAL DE CHÃO FIXO
COMPATÍVEL COM DISPLAYS DE 37" a 55"
MÁXIMO VESA 600 x 400mm
ALTURA AJUSTÁVEL (113-163cm)
VÁRIOS MODELOS E OPÇÕES DISPONÍVEIS

LFAU

SUPORTE UNIVERSAL DE CHÃO FIXO
COMPATÍVEL COM DISPLAYS DE 40" a 80"
MÁXIMO VESA 800 x 400mm
ALTURA AJUSTÁVEL (113-163cm)
VÁRIOS MODELOS E OPÇÕES DISPONÍVEIS

Info VÁRIOS MODELOS E PRODUTOS DISPONÍVEIS
CONSULTE-NOS PARA MAIS INFORMAÇÕES

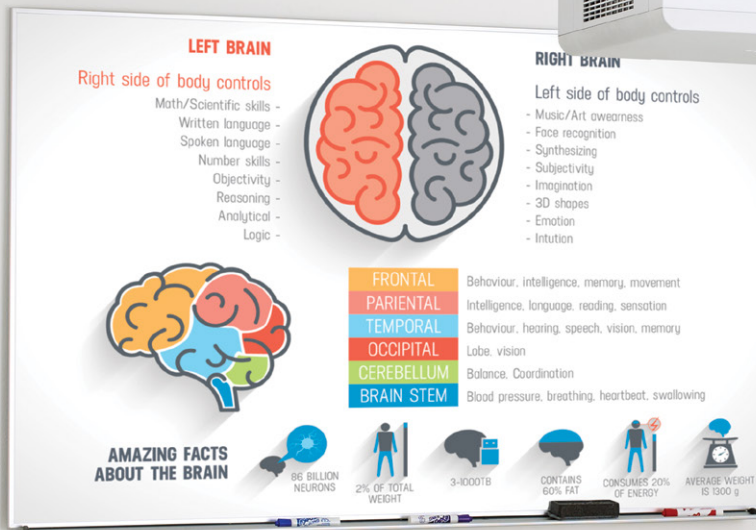

CHIEF® KIT SERIES
 JÁ INCLUI SUPORTE, COLUNA
 AJUSTÁVEL E BASE DE TETO
 2 CORES | 3 TAMANHOS

KITEC030045
 COLUNA 30-45CM

KITEC045080
 COLUNA 45-80CM

KITEC080135
 COLUNA 80-135CM



QUADROS DE PORCELANA
MATERIAL DIDÁTICO
 VER PÁGINA 51

AS MELHORES SOLUÇÕES PARA SALAS DE AULA / FORMAÇÃO

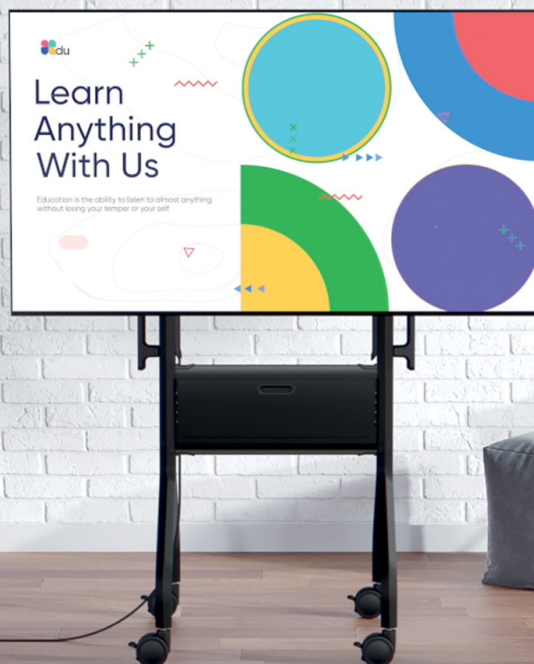

VOYAGER
SUPORTE DE CHÃO
 50" A 75"
 ALTURA AJUSTÁVEL

PROJECTOR / DISPLAY MOUNT SOLUTIONS

VÍDEOPROJETOR / DISPLAYS



20KG
MAX

340W

SUPORTE UNIVERSAL DE TETO

ALTURA FIXA DE 13CM
TILT +15° -15° | ROTAÇÃO 90°

Branco



20KG
MAX

350S/W

SUPORTE UNIVERSAL DE TETO / PAREDE

BRAÇO EXTENSÍVEL DE 43 A 65CM (TETO) 35 A 56CM (PAREDE)
TILT +15° -15° | ROTAÇÃO 90°

Silver

Branco



VESA
600x400



DISPLAY
70" MAX

295

SUPORTE UNIVERSAL DE CHÃO COM RODAS

COMPATÍVEL COM DISPLAYS DE 32" a 70"
ALTURA AJUSTÁVEL DE 1200 A 1800MM.
INCLUI PRATELEIRA EM VIDRO.

Silver / Preto



VESA
800x600



DISPLAY
86" MAX

VWA1165

SUPORTE UNIVERSAL DE CHÃO COM RODAS

COMPATÍVEL COM DISPLAYS DE 50" a 86"
ALTURA AJUSTÁVEL DE 1285 A 1410MM.
INCLUI 1 PRATELEIRA.

Dark Grey



VESA
1000x600



DISPLAY
120" MAX

VWA1130B

SUPORTE UNIVERSAL DE CHÃO COM RODAS

COMPATÍVEL COM DISPLAYS DE 70" a 120"
ALTURA AJUSTÁVEL DE 1250 A 1600MM.
INCLUI 2 PRATELEIRAS.

Preto



VESA
600x400

040

SUPORTE UNIVERSAL DE PAREDE

COMPATÍVEL COM DISPLAYS DE 37" a 90"
TILT +0° -10°

Preto



VESA
400x400

WM420T

SUPORTE UNIVERSAL DE PAREDE

COMPATÍVEL COM DISPLAYS DE 32" a 65"
TILT +0° -10°, ROTAÇÃO 180°, LEVELING +5° -5°

Preto



VESA
600x400

275

SUPORTE UNIVERSAL DE PAREDE

COMPATÍVEL COM DISPLAYS DE 37" a 70"
TILT +5° -15°, ROTAÇÃO 120°, SWIVEL +3° -3°

Preto

IDEAL PARA
VIDEO
CONFERÊNCIA

AUTOMATED PROJECTOR LIFT
SOLUÇÕES DE ENCASTRAR MOTORIZADAS



IDEAL PARA TETOS FALSOS

IDEAL PARA PROJETORES HOME CINEMA

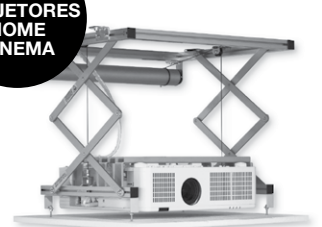
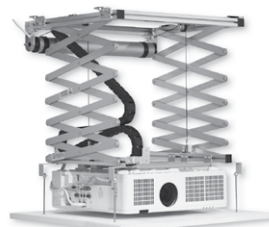
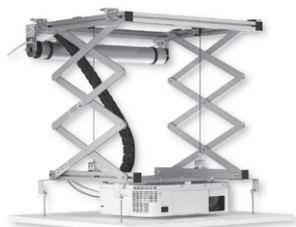
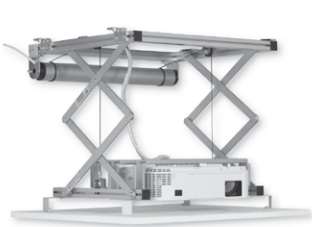

SI-30

13cm
Altura Mínima

48cm
Descida MAX

15 KG
MAX

SI-100

16cm
Altura Mínima

97cm
Descida MAX

15 KG
MAX

SI-200

24cm
Altura Mínima

196cm
Descida MAX

15 KG
MAX

SI-H L 100

15,5cm
Altura Mínima

97cm
Descida MAX

30 KG
MAX

SI-H L 200

25,5cm
Altura Mínima

197cm
Descida MAX

30 KG
MAX

SI-H L 40 HC

14cm
Altura Mínima

54cm
Descida MAX

30 KG
MAX

FECHADO

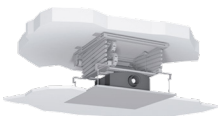

ABERTO



ACESSÓRIOS OPCIONAIS

NECESSÁRIO EM TODOS OS SUPORTES



+ COMANDO E TAMPA EMBELEZADORA



Info VÁRIOS MODELOS E PRODUTOS DISPONÍVEIS
AMPLA GAMA DE SUPORTES MOTORIZADOS
CONSULTE-NOS PARA MAIS INFORMAÇÕES

MIMI

SUPORTE MOTORIZADO DE CHÃO
COMPATÍVEL COM DISPLAYS ATÉ 95"
ALTURA AJUSTÁVEL EM 65CM. (MOTOR)
INCLINAÇÃO ATÉ 90° (MANUAL)



INCLUI TOMADAS 



XL-W

SUPORTE MOTORIZADO DE PAREDE / CHÃO
COMPATÍVEL COM DISPLAYS ATÉ 65"
ALTURA AJUSTÁVEL EM 100CM. (MOTOR)
PESO MÁXIMO 65KG



PT-ACRÍLICO

PÚLPITO DE ORADOR EM ACRÍLICO
TRANSPARENTE COM INCLINAÇÃO REGULÁVEL
ALTURA DE 1200MM



 VÁRIAS OPÇÕES DISPONÍVEIS

PFMT220T

MESA DE PROJEÇÃO
AJUSTÁVEL EM ALTURA: 470-910MM
INCLUI BOLSA DE TRANSPORTE



TABLE BASIC

MESA / CARRINHO DE PROJEÇÃO
AJUSTÁVEL EM ALTURA: 700-1100MM



DM3200

SUPORTE DE SECRETÁRIA PARA MONITORES
COMPATÍVEL COM DISPLAYS DE 17" a 32"
VESA 75X75 / 100X100mm
VÁRIOS MODELOS E OPÇÕES DISPONÍVEIS



HORIZONTAL
VERTICAL



9 KG
MAX
POR DISPLAY

DM1201H

SUPORTE DE SECRETÁRIA PARA MONITORES
COMPATÍVEL COM DISPLAYS DE 13" a 32"
VESA 75X75 / 100X100mm
VÁRIOS MODELOS E OPÇÕES DISPONÍVEIS



HORIZONTAL
VERTICAL



8 KG
MAX
POR DISPLAY



VÁRIOS MODELOS E PRODUTOS DISPONÍVEIS
AMPLA GAMA DE SUPORTES
CONSULTE-NOS PARA MAIS INFORMAÇÕES



QUADROS DE PORCELANA
 PARA ESCRITA A MARCADORES
 CAIXILHARIA EM ALUMÍNIO
 VÁRIOS FORMATOS / ACABAMENTOS
 DISPONÍVEIS DE 45x60cm / 120x500cm

Branca Verde Preta

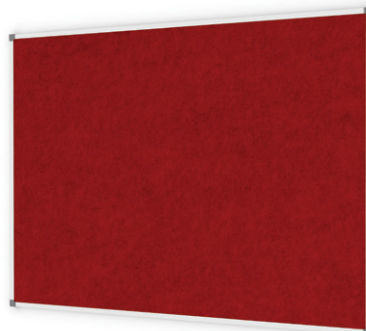

QUADROS DE CORTIÇA / FORRADOS A TECIDO
 VÁRIOS FORMATOS / ACABAMENTOS
 DISPONÍVEIS DE 45x60cm / 120x500cm

Branca Verde Cinza Azul Bordeaux

MARCADORES

PARA USAR EM
 QUADROS BRANCOS
 OU DE VIDRO
CAIXA 10 UNID.



SUPORTE

MAGNÉTICO
 PARA QUADROS
CAIXA 1 UNID.



APAGADOR

FELTRO
 MAGNÉTICO
CAIXA 1 UNID.



RECARGAS

FELTRO
CAIXA 10 UNID.



VÁRIOS MODELOS E PRODUTOS DISPONÍVEIS
 AMPLA GAMA DE MATERIAL ESCOLAR
 CONSULTE-NOS PARA MAIS INFORMAÇÕES





EXPERIENCE & INNOVATION
20 ANOS
EXPERIENCE & INNOVATION

AS MELHORES SOLUÇÕES EM AUDIOVISUAIS

COMPLETE MEETING ROOM SOLUTIONS · HYBRID MEETING ROOMS · ACTIVE CLASSROOMS · MICROSOFT TEAMS & ZOOM ROOMS
CONFERENCE & TRANSLATION · PRESENTATION & COLLABORATION · VIDEOPROJECTION & LARGE FORMAT DISPLAYS · PROFESSIONAL AUDIO & VIDEO
VIDEOCONFERENCE · WEBCAST & STREAMING · DIGITAL SIGNAGE · MULTIMEDIA KIOSKS · INTERACTIVE TECHNOLOGIES · CONTROL & AUTOMATION
SIGNAL MANAGEMENT, DISTRIBUTION AND ROUTING · AV BESPOKE FURNITURE · SPECIALIZED TECHNICAL INSTALLATIONS · AV PROJECTS CONSULTING

15. CONTRATOS DE MANUTENÇÃO



SERVIÇOS DE VALOR ACRESCENTADO

DISPOMOS DE SERVIÇOS DE ASSISTÊNCIA TÉCNICA E MANUTENÇÃO DE EQUIPAMENTOS, À MEDIDA DAS SUAS NECESSIDADES.



OS NOSSOS SERVIÇOS CONTEMPLAM UMA CRIAÇÃO DE SISTEMAS DE CONTROLO DE MANUTENÇÕES PREVENTIVAS E CORRETIVAS, PLANEADAS OU NÃO. ESTAS AÇÕES SÃO EXECUTADAS ATRAVÉS DE INSPEÇÕES PLANEADAS, SISTEMÁTICAS, DETEÇÃO E MEDIDAS NECESSÁRIAS PARA EVITAR FALHAS INCIPIENTES COM A FINALIDADE DE CONSERVAR UM ITEM OU EQUIPAMENTO DENTRO DAS EXPECTATIVAS.



PODEMOS DAR RESPOSTAS DEPENDENDO DA LOCALIZAÇÃO E CONTRATO, ATÉ 72 HORAS COM TROCA DE EQUIPAMENTO INCLuíDO.

PROLONGAR O TEMPO DE VIDA ÚTIL DOS EQUIPAMENTOS

REDUÇÃO DE CUSTOS OPERACIONAIS



RELATÓRIOS DETALHADOS DE TODAS AS INTERVENÇÕES

VÁRIOS NÍVEIS DE SERVIÇOS



DESLOCAÇÕES INCLuíDAS SEM CUSTOS ADICIONAIS

CONTRATOS DE MANUTENÇÃO

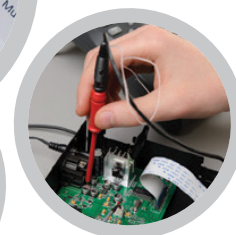
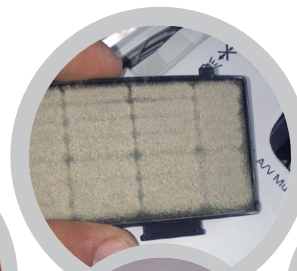

VÁRIOS SERVIÇOS DISPONÍVEIS
CONSULTE-NOS PARA MAIS INFORMAÇÕES

FASTLAMPS®

O SEU SITE DE LÂMPADAS



fastlamps.pt



24 25

é[®]
SISTEMAS
VISUAL COMMUNICATION SOLUTIONS
MULTIMEDIA PRODUCTS

**EDU
CATION
SOLU
TIONS**

esistemas.pt

Distributed by: | Distribuído por:

TODAS AS CARACTERÍSTICAS E IMAGENS PODER ESTAR SUJEITAS A ALTERAÇÕES SEM AVISO PRÉVIO.
A ESTIMOS NÃO É RESPONSÁVEL POR QUALQUER ERRO TIPOGRÁFICO.